

Enumeration of Matchings: Problems and Progress

JAMES PROPP

Dedicated to the memory of David Klarner (1940–1999)

ABSTRACT. This document is built around a list of thirty-two problems in enumeration of matchings, the first twenty of which were presented in a lecture at MSRI in the fall of 1996. I begin with a capsule history of the topic of enumeration of matchings. The twenty original problems, with commentary, comprise the bulk of the article. I give an account of the progress that has been made on these problems as of this writing, and include pointers to both the printed and on-line literature; roughly half of the original twenty problems were solved by participants in the MSRI Workshop on Combinatorics, their students, and others, between 1996 and 1999. The article concludes with a dozen new open problems.

1. Introduction

How many perfect matchings does a given graph G have? That is, in how many ways can one choose a subset of the edges of G so that each vertex of G belongs to one and only one chosen edge? (See Figure 1(a) for an example of a perfect matching of a graph.) For general graphs G , it is computationally hard to obtain the answer [Valiant 1979], and even when we have the answer, it is not so clear that we are any the wiser for knowing this number. However, for many infinite families of special graphs the number of perfect matchings is given by compellingly simple formulas. Over the past ten years a great many families of this kind have been discovered, and while there is no single unified result that encompasses all of them, many of these families resemble one another, both in terms of the form of the results and in terms of the methods that have been useful in proving them.

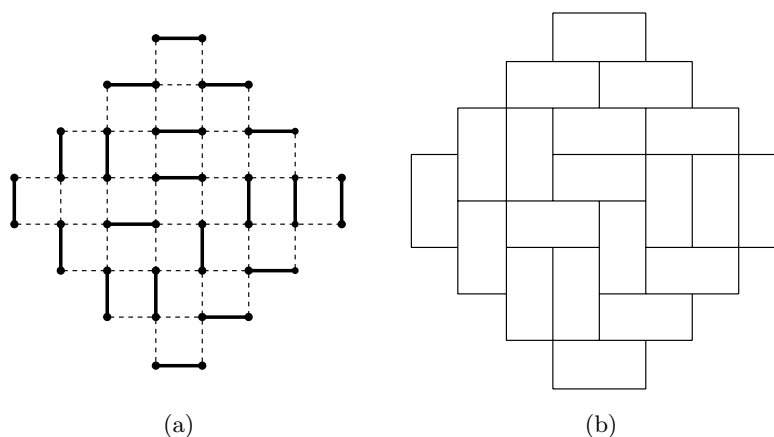

Figure 1. The Aztec diamond of order 4.

The deeper significance of these formulas is not clear. Some of them are related to results in representation theory or the theory of symmetric functions, but others seem to be self-contained combinatorial puzzles. Much of the motivation for this branch of research lies in the fact that we are still unable to predict ahead of time which enumerative problems lead to beautiful formulas and which do not; each new positive result seems like an undeserved windfall.

Hereafter, I will use the term “matching” to signify “perfect matching”. (See the book of Lovász and Plummer [1986] for general background on the theory of matchings.)

As far as I have been able to determine, problems involving enumeration of matchings were first examined by chemists and physicists in the 1930s, for two different (and unrelated) purposes: the study of aromatic hydrocarbons and the attempt to create a theory of the liquid state.

Shortly after the advent of quantum chemistry, chemists turned their attentions to molecules like benzene composed of carbon rings with attached hydrogen atoms. For these researchers, matchings of a graph corresponded to “Kekulé structures”, i.e., ways of assigning single and double bonds in the associated hydrocarbon (with carbon atoms at the vertices and tacit hydrogen atoms attached to carbon atoms with only two neighboring carbon atoms). See for example the article of Gordon and Davison [1952], whose use of nonintersecting lattice paths anticipates certain later work [Gessel and Viennot 1985; Sachs 1990; John and Sachs 1985]. There are strong connections between combinatorics and chemistry for such molecules; for instance, those edges which are present in comparatively few of the matchings of a graph turn out to correspond to the bonds that are least stable, and the more matchings a polyhex graph possesses the more stable is the corresponding benzenoid molecule. Since hexagonal rings are so predominant in the structure of hydrocarbons, chemists gave most of their attention to counting matchings of subgraphs of the infinite honeycomb grid.

At approximately the same time, scientists were trying to understand the behavior of liquids. As an extension of a more basic model for liquids containing only molecules of one type, Fowler and Rushbrooke [1937] devised a lattice-based model for liquids containing two types of molecules, one large and one small. In the case where the large molecule was roughly twice the size of the small molecule, it made sense to model the small molecules as occupying sites of a three-dimensional grid and the large molecules as occupying pairs of adjacent sites. In modern parlance, this is a monomer-dimer model. In later years, the two-dimensional version of the model was found to have applicability to the study of molecules adsorbed on films; if the adsorption sites are assumed to form a lattice, and an adsorbed molecule is assumed to occupy two such sites, then one can imagine fictitious molecules that occupy all the unoccupied sites (one each).

Major progress was made when Temperley and Fisher [1961] and Kasteleyn [1961] independently found ways to count pure dimer configurations on subgraphs of the infinite square grid, with no monomers present. Although the physical significance of this special case was (and remains) unclear, this result, along with Onsager’s earlier exact solution of the two-dimensional Ising model [Onsager 1944], paved the way for other advances such as Lieb’s exact solution of the six-vertex model [Lieb 1967], culminating in a new field at the intersection of physics and mathematics: exactly solved statistical mechanics models in two-dimensional lattices. (Intriguingly, virtually none of the three- and higher-dimensional analogues of these models have succumbed to researchers’ efforts at obtaining exact solutions.) For background on lattice models in statistical mechanics, see the book by Baxter [1982].

An infinite two-dimensional grid has many finite subgraphs; in choosing which ones to study, physicists were guided by the idea that the shape of boundary should be chosen so as to minimize the effect of the boundary—that is, to maximize the number of configurations, at least in the asymptotic sense. For example, Kasteleyn, in his study of the dimer model on the square grid, counted the matchings of the m -by- n rectangle (see the double-product formula at the beginning of Section 5) and of the m -by- n rectangular torus, and showed that the two numbers grow at the same rate as m, n go to infinity, namely C^{mn} for a known constant C . (Analytically, C is $e^{G/\pi}$, where G is Catalan’s constant $1 - \frac{1}{9} + \frac{1}{25} - \frac{1}{49} + \frac{1}{81} - \dots$; numerically, C is approximately 1.34.)

Kasteleyn [1961] wrote: “The effect of boundary conditions is, however, not entirely trivial and will be discussed in more detail in a subsequent paper.” (See the article of Cohn, Kenyon and Propp [Cohn et al. 1998a] for a rigorous mathematical treatment of boundary conditions.) Kasteleyn never wrote such a followup paper, but other physicists did give some attention to the issue of boundary shape, most notably Gensburg, Carlsen and Zapp [Gensburg et al. 1980]. These authors considered a one-parameter family of graphs of the kind shown in Figure 1(a), and they asserted that every graph in this family has $2^{N/4}$

matchings, where N is the number of vertices. They did not give a proof, nor did they indicate whether they had one. The result was rediscovered in the late 1980s by Elkies, Kuperberg, Larsen, and Propp [Elkies et al. 1992], who gave four proofs of the formula. This article led to a great deal of work among enumerative combinatorialists, who refer to graphs like the one shown in Figure 1 as “Aztec diamond graphs”, or sometimes just Aztec diamonds for short. (It should be noted that Elkies et al. [1992] used the term “Aztec diamond” to denote regions like the one shown in Figure 1(b). The two sorts of Aztec diamonds are dual to one another; matchings of Aztec diamond graphs correspond to domino tilings of Aztec diamond regions.)

At about the same time, it became clear that there had been earlier work within the combinatorial community that was pertinent to the study of matchings, though its relevance had not hitherto been recognized. For instance, Mills, Robbins and Rumsey [Mills et al. 1983], in their work on alternating sign matrices, had counted pairs of “compatible” ASMs of consecutive size; these can be put into one-to-one correspondence with matchings of an associated Aztec diamond graph [Elkies et al. 1992].

Looking into earlier mathematical literature, one can even see intimations of enumerative matching theory in the work of MacMahon [1915–16], who nearly a century ago found a formula for the number of plane partitions whose solid Young diagram fits inside an a -by- b -by- c box, as will be discussed in Section 2. (See the book by Andrews [1976] and the article by Stanley [1971] for background on plane partitions.) Such a Young diagram is nothing more than an assemblage of cubes, and it has long been known in the extra-mathematical world that such assemblages, viewed from a distant point, looks like tilings (consider Islamic art, for instance). Thus it was natural for mathematicians to interpret MacMahon’s theorem on plane partitions as a result about tilings of a hexagon by rhombuses. This insight may have occurred to a number of people independently; the earliest chain of oral communication that I have followed leads back to Klarner (who did not publish his observation but relayed it to Stanley in the 1970s), and the earliest published statement I have found is in a paper by David and Tomei [1989].

In any case, each of the Young diagrams enumerated by MacMahon corresponds to a tiling of a hexagon by rhombuses, where the hexagon is semiregular (its opposite sides are parallel and of equal length, with all internal angles equal to 120 degrees) and has side-lengths a, b, c, a, b, c , and where the rhombuses have all side-lengths equal to 1. These tilings in turn correspond to matchings of the “honeycomb” graph that is dual to the dissection of the hexagon into unit equilateral triangles; see Figure 2, which shows a matching of the honeycomb graph and the associated tiling of a hexagon. Kuperberg [1994] was the first to exploit the connection between plane partitions and the dimer model. (Interestingly, some of the same graphs that Kuperberg studied had been investigated independently by chemists in their study of benzenoids hydrocarbons; Cyvin and Gutman [1988] give a survey of this work.)

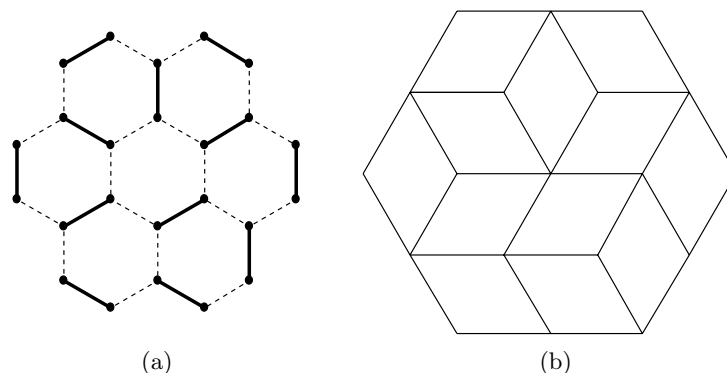

Figure 2. A matching and its associated tiling.

Similarly, variants of MacMahon’s problem in which the plane partition is subjected to various symmetry constraints (considered by Macdonald, Stanley, and others [Stanley 1986a; 1986b]) correspond to the problem of enumerating matchings possessing corresponding kinds of symmetry. Kuperberg [1994] used this correspondence in solving one of Stanley’s open problems, and this created further interest in matchings among combinatorialists.

One of Kuperberg’s chief tools was an old result of Kasteleyn, which showed that for any planar graph G , the number of matchings of G is equal to the Pfaffian of a certain matrix of zeros and ones associated with G . A special case of this result, enunciated by Percus [1969], can be used when G is bipartite; in this case, one can use a determinant instead of a Pfaffian. Percus’ determinant is a modified version of the bipartite adjacency matrix of the graph, in which rows correspond to “white” vertices and columns correspond to “black” vertices (under a coloring scheme whereby white vertices have only black neighbors and vice versa); the (i, j) -th entry is ± 1 if the i -th white vertex and j -th black vertex are adjacent, and 0 otherwise. For more details on how the signs of the entries are chosen, see the expositions of Kasteleyn [1967] and Percus [1969].

Percus’ theorem, incorporated into computer software, makes it easy to count the matchings of many planar graphs and look for patterns in the numbers that arise. Two such programs are `vaxmaple`, written by Greg Kuperberg, David Wilson and myself, and `vaxmacs`, written by David Wilson. Most of the patterns described below were discovered with the aid of this software, which is available from <http://math.wisc.edu/~propp/software.html>. Both programs treat subgraphs of the infinite square grid; this might seem restrictive, but it turns out that counting the matchings of an arbitrary bipartite planar graph can be fit into this framework, with a bit of tweaking. The mathematically interesting part of each program is the routine for choosing the signs of the nonzero entries. There are many choices that would work, but Wilson’s sign-rule is far and away the simplest: If an edge is horizontal, we give it weight $+1$, and if an edge is vertical, joining a vertex in one row to a vertex in the row below it, we give the

edge weight $(-1)^k$, where k is the number of vertices in the upper row to the left of the vertical edge.

The main difference between `vaxmaple` and `vaxmacs` is that the former creates Maple code which, if sent to Maple, results in Maple printing out the number of matchings of the graph; `vaxmacs`, on the other hand, is a customized EMACS environment that fully integrates text-editing operations (used for defining the graph one wishes to study) with the mathematical operations of interest. Both programs represent bipartite planar graphs in “VAX-format”, where V’s, A’s, X’s, and other letters denote vertices. (An example of VAX-format can be found on page 261; for a detailed explanation see <http://math.wisc.edu/~propp/vaxmaple.doc>.)

Quite recently, the study of matchings of nonbipartite graphs has been expedited by the programs `graph` and `planemaple`, created by Matt Blum and Ben Wieland, respectively. These programs make it easy to define a planar graph by pointing and clicking, after which one can count its matchings using an efficient implementation of Kasteleyn’s Pfaffian method. This makes it easy to try out new ideas and look for patterns, outside of the better-explored bipartite case.

Interested readers with access to the World Wide Web can obtain copies of all of these programs via <http://math.wisc.edu/~propp/software.html>.

Most of the formulas that have been discovered express the number of matchings of a graph as a product of many comparatively small factors. Even before one has conjectured (let alone proved) such a formula, one can frequently infer its existence from the fact that the number of matchings has only small prime factors. Numbers that are large compared to their largest prime factor are sometimes called “smooth” or “round”; the latter term will be used here. The definition of roundness is not precise, since it is not intended for use as a technical term. Its vagueness is intended to capture the uncertainties and the suspense of formula-hunting, and the debatable issue of whether the occurrence of a single larger-than-expected prime factor rules out the existence of a product formula. (For an example of a number whose roundness lies in this gray area, see the table of numbers given in Problem 8.) It is worth noting that Kuperberg [1998, Section VII-A] has shown that rigorous proofs of roundness need not always yield explicit product formulas.

Christian Krattenthaler has written a Mathematica program called RATE that greatly expedites the process of guessing patterns in experimental data on enumeration of matchings; see <http://radon.mat.univie.ac.at/People/kratt/rate/rate.html>.

A great source of the appeal of research on enumeration of matchings is the ease with which undergraduate research assistants can participate in the hunt for formulas and proofs; many members of the M.I.T. Tilings Research Group (composed mostly of undergraduates like Blum and Wieland) played a role in the developments that led to the writing of this article. Enumeration of matchings

has turned out to be a rich avenue of combinatorial inquiry, and many more beautiful patterns undoubtedly await discovery.

Updates on the status of these problems can be found on the Web at <http://math.wisc.edu/~propp/update.ps.gz>.

2. Lozenges

We begin with problems related to lozenge tilings of hexagons. A *lozenge* is a rhombus of side-length 1 whose internal angles measure 60 and 120 degrees; all the hexagons we will consider will tacitly have integer side-lengths and internal angles of 120 degrees. Every such hexagon H can be dissected into unit equilateral triangles in a unique way, and one can use this dissection to define a graph G whose vertices correspond to the triangles and whose edges correspond to pairs of triangles that share an edge; this is the “finite honeycomb graph” dual to the dissection. It is easy to see that the tilings of H by lozenges are in one-to-one correspondence with the matchings of G .

The a, b, c semiregular hexagon is the hexagon whose side lengths are, in cyclical order, a, b, c, a, b, c . Lozenge tilings of this region are in correspondence with plane partitions with at most a rows, at most b columns, and no part exceeding c . Such hexagons are represented in VAX-format by diagrams like

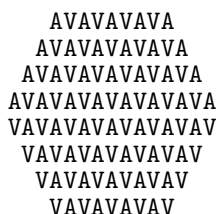

where A’s and V’s represent upward-pointing and downward-pointing triangles, respectively. In this article we will use triangles instead:

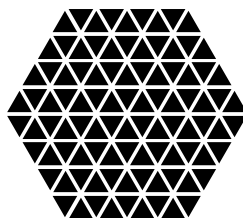

MacMahon [1915–16] showed that the number of such plane partitions is

$$\prod_{i=0}^{a-1} \prod_{j=0}^{b-1} \prod_{k=0}^{c-1} \frac{i+j+k+2}{i+j+k+1}.$$

(This form of MacMahon’s formula is due to Macdonald; a short, self-contained proof is given by Cohn et al. [1998b, Section 2].)

PROBLEM 1. Show that in the $2n-1, 2n, 2n-1$ semiregular hexagon, the central location (consisting of the two innermost triangles) is covered by a lozenge in exactly one-third of the tilings.

(Equivalently: Show that if one chooses a random matching of the dual graph, the probability that the central edge is contained in the matching is exactly $\frac{1}{3}$.)

PROGRESS. Two independent and very different solutions of this problem have been found; one by Mihai Ciucu and Christian Krattenthaler and the other by Harald Helfgott and Ira Gessel. Ciucu and Krattenthaler [1999] compute more generally the number of rhombus tilings of a hexagon with sides a, a, b, a, a, b that contain the central unit rhombus, where a and b must have opposite parity (the special case $a = 2n-1, b = 2n$ solves Problem 1). The same generalization was obtained (in a different but equivalent form) by Helfgott and Gessel [1999], using a completely different method. One might still try to look for a proof whose simplicity is comparable to that of the answer “one-third”. Also worthy of note is the paper of Fulmek and Krattenthaler [1998a], which generalizes the result of Ciucu and Krattenthaler [1999].

The hexagon of side-lengths $n, n+1, n, n+1, n, n+1$ cannot be tiled by lozenges at all, for in the dissection into unit triangles, the number of upward-pointing triangles differs from the number of downward-pointing triangles. However, if one removes the central triangle, one gets a region that can be tiled, and the sort of numbers one gets for small values of n are striking. Here they are, in factored form:

$$\begin{aligned}
 & 2 \\
 & 2 \cdot 3^3 \\
 & 2^5 \cdot 3^3 \cdot 5 \\
 & 2^5 \cdot 5^7 \\
 & 2^2 \cdot 5^7 \cdot 7^5 \\
 & 2^8 \cdot 3^3 \cdot 5 \cdot 7^{11} \\
 & 2^{13} \cdot 3^9 \cdot 7^{11} \cdot 11 \\
 & 2^{13} \cdot 3^{18} \cdot 7^5 \cdot 11^7 \\
 & 2^8 \cdot 3^{18} \cdot 11^{13} \cdot 13^5 \\
 & 2^2 \cdot 3^9 \cdot 11^{19} \cdot 13^{11} \\
 & 2^{10} \cdot 3^3 \cdot 11^{19} \cdot 13^{17} \cdot 17 \\
 & 2^{16} \cdot 11^{13} \cdot 13^{23} \cdot 17^7
 \end{aligned}$$

These are similar to the numbers one gets from counting lozenge tilings of an n, n, n, n, n, n hexagon, in that the largest prime factor seems to be bounded by a linear function of n .

PROBLEM 2. Enumerate the lozenge tilings of the region obtained from the $n, n+1, n, n+1, n, n+1$ hexagon by removing the central triangle.

PROGRESS. Mihai Ciucu has solved the more general problem of counting the rhombus tilings of an $(a, b+1, b, a+1, b, b+1)$ -hexagon with the central triangle removed [Ciucu 1998]. Ira Gessel proved this result independently using the non-intersecting lattice-paths method [Helfgott and Gessel 1999]. Soichi Okada and Christian Krattenthaler have solved the even more general problem of counting the rhombus tilings of an $(a, b+1, c, a+1, b, c+1)$ -hexagon with the central triangle removed [Okada and Krattenthaler 1998].

One can also take a $2n, 2n+3, 2n, 2n+3, 2n, 2n+3$ hexagon and make it lozenge-tilable by removing a triangle from the middle of each of its three long sides, as shown:

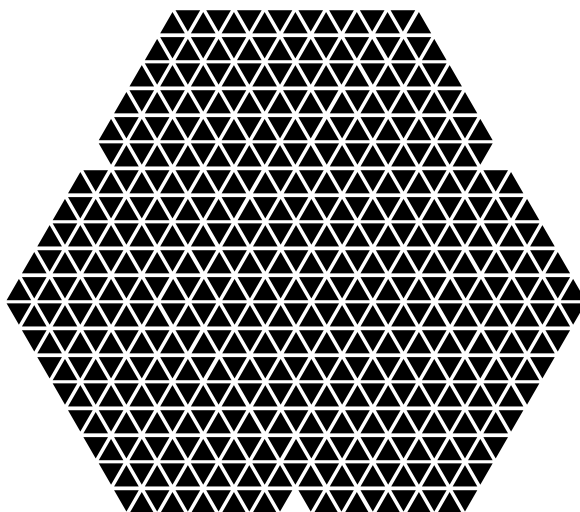

Here one obtains an equally tantalizing sequence of factorizations:

$$\begin{aligned}
 &1 \\
 &2^7 \cdot 7^2 \\
 &2^2 \cdot 7^4 \cdot 11^4 \cdot 13^2 \\
 &2^{10} \cdot 3^3 \cdot 5^8 \cdot 13^2 \cdot 17^4 \cdot 19^2 \\
 &2^2 \cdot 5^2 \cdot 7^2 \cdot 11^3 \cdot 13^4 \cdot 17^4 \cdot 19^8 \cdot 23^4
 \end{aligned}$$

PROBLEM 3. Enumerate the lozenge tilings of the region obtained from the $2n, 2n+3, 2n, 2n+3, 2n, 2n+3$ hexagon by removing a triangle from the middle of each of its long sides.

PROGRESS. Theresia Eisenkölbl solved this problem. What she does in fact is to compute the number of all rhombus tilings of a hexagon with sides $a, b+3, c, a+3, b, c+3$, where an arbitrary triangle is removed from each of the “long” sides

of the hexagon (not necessarily the triangle in the middle). For the proof of her formula [Eisenkölbl 1997] she uses nonintersecting lattice paths, determinants, and the Jacobi determinant formula [Turnbull 1960]. However, I still know of no conceptual explanation for why these numbers are so close (in the multiplicative sense) to being perfect squares.

We now return to ordinary a, b, c semiregular hexagons. When $a = b = c$, there are not two but six central triangles. There are two geometrically distinct ways in which we can choose to remove an upward-pointing triangle and downward-pointing triangle from these six, according to whether the triangles are opposite or adjacent:



Such regions may be called “holey hexagons” of two different kinds. Matt Blum tabulated the number of lozenge tilings of these regions, for small values of $a = b = c$. In the first (“opposite”) case, the number of tilings of the holey hexagon is a nice round number (its greatest prime factor appears to be bounded by a linear function of the size of the region). In the second (“adjacent”) case, the number of tilings is not round. Note, however, that in the second case, the number of tilings of the holey hexagon divided by the number of tilings of the unaltered hexagon (given to us by MacMahon’s formula) is equal to the probability that a random lozenge tiling of the hexagon contains a lozenge that covers these two triangles; this probability tends to $\frac{1}{3}$ for large a , at least on average [Cohn et al. 1998b]. Following this clue, we examine the difference between the aforementioned probability (with its messy, un-round numerator) and the number $\frac{1}{3}$. The result is a fraction in which the numerator is now a nice round number. So, in both cases, we have reason to think that there is an exact product formula.

PROBLEM 4. Determine the number of lozenge tilings of a regular hexagon from which two of its innermost unit triangles (one upward-pointing and one downward-pointing) have been removed.

PROGRESS. Theresia Eisenkölbl solved the first case of Problem 4 and Markus Fulmek and Christian Krattenthaler solved the second case. Eisenkölbl [1998] solves a generalization of the problem by applying Mihai Ciucu’s matchings factorization theorem, nonintersecting lattice paths, and a nontrivial determinant evaluation. Fulmek and Krattenthaler [1998b] compute the number of rhombus tilings of a hexagon with sides a, b, a, a, b, a (with a and b having the same parity) that contain the rhombus that touches the center of the hexagon and lies symmetric with respect to the symmetry axis that runs parallel to the sides

of length b . For the proof of their formula they compute Hankel determinants featuring Bernoulli numbers, which they do by using facts about continued fractions, orthogonal polynomials, and, in particular, continuous Hahn polynomials. The special case $a = b$ solves the second part of Problem 4.

I mentioned earlier that Kasteleyn’s method, as interpreted by Percus, allows one to write the number of matchings of a bipartite planar graph as the determinant of a signed version of the bipartite adjacency matrix. In the case of lozenge tilings of hexagons and the associated matchings, it turns out that there is no need to modify signs of entries; the ordinary bipartite adjacency matrix will do. Greg Kuperberg [1998] has noticed that when row-reduction and column-reduction are systematically applied to the Kasteleyn–Percus matrix of an a, b, c semiregular hexagon, one can obtain the b -by- b Carlitz matrix [Carlitz and Stanley 1975] whose (i, j) -th entry is $\binom{a+c}{a+i-j}$. (This matrix can also be recognized as the Gessel–Viennot matrix that arises from interpreting each tiling as a family of nonintersecting lattice paths [Gessel and Viennot 1985].) Such reductions do not affect the determinant, so we have a pleasing way of understanding the relationship between the Kasteleyn–Percus matrix method and the Gessel–Viennot lattice-path method. In fact, such reductions do not affect the *cokernel* of the matrix (an abelian group whose order is the determinant). On the other hand, the cokernel of the Kasteleyn–Percus matrix for the a, b, c hexagon is clearly invariant under permuting a, b , and c . This gives rise to three different Carlitz matrices that nontrivially have the same cokernel. For example, if $c = 1$, then one gets an a -by- a matrix and a b -by- b matrix that both have the same cokernel, whose structure can be determined “by inspection” if one notices that the third Carlitz matrix of the trio is just a 1-by-1 matrix whose sole entry is (plus or minus) a binomial coefficient. In this special case, the cokernel is just a cyclic group.

Greg Kuperberg poses this challenge:

PROBLEM 5. Determine the cokernel of the Carlitz matrix, or equivalently of the Kasteleyn–Percus matrix of the a, b, c hexagon, and if possible find a way to interpret the cokernel in terms of the tilings.

This combines Questions 1 and 2 of Kuperberg [1998]. As he points out in that article, in the case $a = b = c = 2$, one gets the noncyclic group $\mathbb{Z}/2\mathbb{Z} \times \mathbb{Z}/10\mathbb{Z}$ as the cokernel.

As was remarked above, one nice thing about the Kasteleyn–Percus matrices of honeycomb graphs is that it is not necessary to make any of the entries negative. For general graphs, however, there is no canonical way of defining K , in the sense that there may be many ways of modifying the signs of certain entries of the bipartite adjacency matrix of a graph so that all nonzero contributions to the determinant have the same sign. Thus, one should not expect the eigenvalues of K to possess combinatorial significance. However, the spectrum of K times its adjoint K^* is independent of which Kasteleyn–Percus matrix K one chooses (as

was independently shown by David Wilson and Horst Sachs). Thus, digressing somewhat from the topic of lozenge tilings, we find it natural to ask:

PROBLEM 6. What is the significance of the spectrum of KK^* , where K is any Kasteleyn–Percus matrix associated with a bipartite planar graph?

PROGRESS. Nicolau Saldanha [1997] has proposed a combinatorial interpretation of the spectrum of KK^* . Horst Sachs says (personal communication) that KK^* may have some significance in the chemistry of polycyclic hydrocarbons (so-called benzenoids) and related compounds as a useful approximate measure of the “degree of aromaticity”.

Returning now to lozenge tilings, or equivalently, matchings of finite subgraphs of the infinite honeycomb, consider the hexagon graph with $a = b = c = 2$:

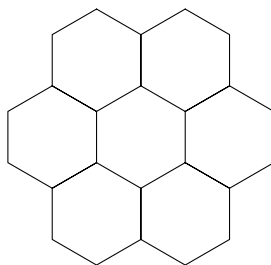

This is the graph whose 20 matchings correspond to the 20 tilings of the regular hexagon of side 2 by rhombuses of side 1. If we look at the probability of each individual vertical edge belonging to a matching chosen uniformly at random (“edge-probabilities”), we get

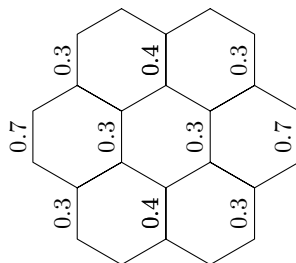

Now look at this table of numbers as if it described a distribution of mass. If we assign the three rows y -coordinates -1 through 1 , we find that the weighted sum of the squares of the y -coordinates is equal to

$$(0.3+0.4+0.3)(-1)^2 + (0.7+0.3+0.7+0.3)(0)^2 + (0.3+0.4+0.3)(1)^2 = 2.$$

If we assign to the seven columns x -coordinates -3 through 3 , we find that the weighted sum of the squares of the x -coordinates is equal to $(0.7)(-3)^2 + (0.6)(-2)^2 + (0.3)(-1)^2 + (0.8)(0)^2 + (0.3)(1)^2 + (0.6)(2)^2 + (0.7)(3)^2 = 20$. You

can do a similar (but even easier) calculation yourself for the case $a = b = c = 1$, to see that the “moments of inertia” of the vertical edge-probabilities around the horizontal and vertical axes are 0 and 1, respectively. Using `vaxmaple` to study the case $a = b = c = n$ for larger values of n , I find that the moment of inertia about the horizontal axis goes like

$$0, 2, 12, 40, 100, \dots$$

and the moment of inertia about the vertical axis goes like

$$1, 20, 93, 296, 725, \dots$$

It is easy to show that the former moments of inertia are given in general by the polynomial $(n^4 - n^2)/6$ (in fact, the number of vertical lozenges that have any particular y -coordinate does not depend on the tiling chosen). The latter moments of inertia are subtler; they are not given by a polynomial of degree 4, though it is noteworthy that the n -th term is an integer divisible by n , at least for the first few values of n .

PROBLEM 7. Find the “moments of inertia” for the mass on edges arising from edge-probabilities for random matchings of the a, b, c honeycomb graph.

3. Dominoes

Now let us turn from lozenge-tiling problems to domino-tiling problems. A *domino* is a 1-by-2 or 2-by-1 rectangle. Although lozenge tilings (in the guise of constrained plane partitions) were studied first, it was really the study of domino tilings in Aztec diamonds that gave current work on enumeration of matchings its current impetus. Here is the Aztec diamond of order 5:

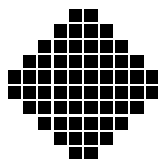

A tiling of such a region by dominos is equivalent to a matching of a certain (dual) subgraph of the infinite square graph. This grid is bipartite, and it is convenient to color its vertices alternately black and white; equivalently, it is convenient to color the 1-by-1 squares alternately black and white, so that every domino contains one 1-by-1 square of each color. Elkies, Kuperberg, Larsen, and Propp showed in [Elkies et al. 1992] that the number of domino tilings of such a region is $2^{n(n+1)/2}$ (where $2n$ is the number of rows), and Gessel, Ionescu, and Propp proved in [Gessel et al. \geq 1999] an exact formula (originally conjectured

by Jockusch) for the number of tilings of regions like

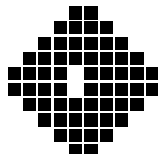

in which two innermost squares of opposite color have been removed. (For some values of n , the number of tilings is exactly $\frac{1}{4}$ times $2^{n(n+1)/2}$; in the other cases, there is an exact product formula for the difference between the number of tilings and $(\frac{1}{4})2^{n(n+1)/2}$. It is this latter fact that motivated the idea of trying something similar in the case of lozenge tilings, as described in the paragraph preceding the statement of Problem 4.)

Now suppose one removes two squares from the middle of an Aztec diamond of order n in the following way:

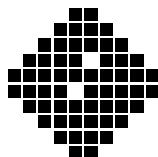

(The two squares removed are a knight's-move apart, and subject to that constraint, they are as close to being in the middle as they can be. Up to symmetries of the square, there is only one way of doing this.) The numbers of tilings one gets are as follows (for $n = 2$ through 10):

$$\begin{aligned}
 &2 \\
 &2^3 \\
 &2^5 \cdot 5 \\
 &2^9 \cdot 3^2 \\
 &2^{17} \cdot 3 \\
 &2^{22} \cdot 3^2 \\
 &2^{24} \cdot 3^2 \cdot 73 \\
 &2^{31} \cdot 3^2 \cdot 5^2 \cdot 11 \\
 &2^{47} \cdot 3^2 \cdot 5
 \end{aligned}$$

Only the presence of the large prime factor 73 makes one doubt that there is a general product formula; the other prime factors are reassuringly small.

PROBLEM 8. Count the domino tilings of an Aztec diamond from which two close-to-central squares, related by a knight's move, have been deleted.

PROGRESS. Harald Helfgott has solved this problem; it follows from the main result in his thesis [1998]. The formula is somewhat complicated, as the prime

factor 73 might have led us to expect. (One of the factors in Helfgott’s product formula is a single-indexed sum; 73 arises as $128 - 60 + 5$.)

One can also look at “Aztec rectangles” from which squares have been removed so as to restore the balance between black and white squares (a necessary condition for tileability). For instance, one can remove the central square from an a -by- b Aztec rectangle in which a and b differ by 1, with the larger of a, b odd:

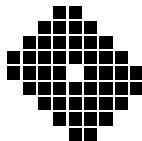

PROBLEM 9. Find a formula for the number of domino tilings of a $2n$ -by- $(2n + 1)$ Aztec rectangle with its central square removed.

PROGRESS. This had already been solved when I posed the problem; it is a special case of a result of Ciucu [1997, Theorem 4.1]. Eric Kuo solved the problem independently.

What about $(2n - 1)$ -by- $2n$ rectangles? For these regions, removing the central square does not make the region tilable. However, if one removes any one of the four squares adjacent to the middle square, one obtains a region that is tilable, and moreover, for this region the number of tilings appears to be a nice round number.

PROBLEM 10. Find a formula for the number of domino tilings of a $(2n - 1)$ -by- $2n$ Aztec rectangle with a square adjoining the central square removed.

PROGRESS. This problem was solved independently three times: by Harald Helfgott and Ira Gessel [1999], by Christian Krattenthaler [1997], and by Eric Kuo (private communication). Gessel and Helfgott solve a more general problem than Problem 10. Krattenthaler’s preprint gives several results concerning the enumeration of matchings of Aztec rectangles where (a suitable number of) collinear vertices are removed, of which Problem 10 is just a special case. There is some overlap between the results of Helfgott and Gessel and the results of Krattenthaler.

At this point, some readers may be wondering why m -by- n rectangles have not played a bigger part in the story. Indeed, one of the surprising facts of life in the study of enumeration of matchings is that Aztec diamonds and their kin have been much more fertile ground for exact combinatorics than the seemingly more natural rectangles. There are, however, a few cases I know of in which something rather nice turns up. One is the problem of Ira Gessel that appears as Problem 20 in this document. Another is the work done by Jockusch [1994] and, later, Ciucu [1997] on why the number of domino tilings of the square is always either a perfect square or twice a perfect square. In the spirit of the work

of Jockusch and Ciucu, I offer here a problem based on Lior Pachter’s observation [Pachter and Kim 1998] that the region on the left below, obtained by removing 8 dominos from a 16-by-16 square, has exactly one tiling. What if we make the intrusion half as long, as in the region on the right?

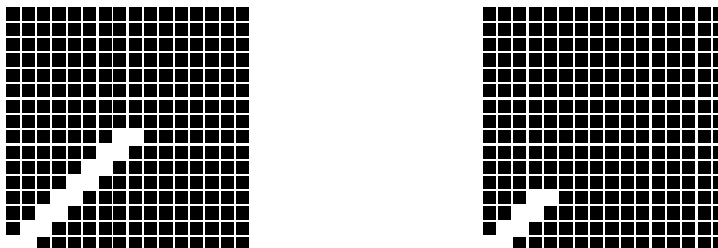

That is, we take a $2n$ -by- $2n$ square (with n even) and remove $n/2$ dominos from it, in a partial zig-zag pattern that starts from the corner. Here are the numbers we get, in factored form, for $n = 2, 4, 6, 8, 10$:

$$\begin{aligned} &2 \cdot 3^2 \\ &2^2 \cdot 3^6 \cdot 13^2 \\ &2^3 \cdot 3^2 \cdot 5^4 \cdot 7^2 \cdot 3187^2 \\ &2^4 \cdot 11771899^2 \cdot 27487^2 \\ &2^5 \cdot 2534588575976069659^2 \end{aligned}$$

The factors are ugly, but the exponents are nice: we get $2^{n/2}$ times an odd square.

Perhaps this is a special case of a two-parameter fact that says that you can take an intrusion of length m in a $2n$ -by- $2n$ square and the number of tilings of the resulting region will always be a square or twice a square.

PROBLEM 11. What is going on with “intruded Aztec diamonds”? In particular, why is the number of tilings so square-ish?

It should also be noted that the square root of the odd parts of these numbers ($3, 3^3 \cdot 13$, etc.) alternate between 1 and 3 mod 4. Perhaps these quantities are continuous functions of n in the 2-adic sense, as is the case for intact $2n$ -by- $2n$ squares [Cohn 1999]; however, the presence of large prime factors means that no simple product formula is available, and that the analysis will require new techniques.

We now return to the Kasteleyn–Percus matrices discussed earlier. Work of Rick Kenyon and David Wilson [Kenyon 1997] has shown that the *inverses* of these matrices are loaded with combinatorial information, so it would be nice to get our hands on them. Unfortunately, there are many nonzero entries in the inverse-matrices. (Recall that the Kasteleyn–Percus matrices themselves, being nothing more than adjacency matrices in which some of the 1’s have been strategically replaced by -1 ’s, are sparse; their inverses, however, tend to have most

if not all of their entries nonzero.) Nonetheless, some exploratory “numerology” leaves room for hope that this is do-able.

Consider the Kasteleyn–Percus matrix K_n for the Aztec diamond of order n , in which every vertical domino with its white square on top (relative to some fixed checkerboard coloring) has its sign inverted—that is, the corresponding 1 in the bipartite adjacency matrix is replaced by -1 .

PROBLEM 12. Show that the sum of the entries of the matrix inverse of K_n is $\frac{1}{2}(n-1)(n+3) - 2^{n-1} + 2$.

(This formula works for $n = 1$ through $n = 8$.)

PROGRESS. Harald Helfgott has solved a similar problem using the main result of his thesis [1998], and it is likely that the result asserted in Problem 12 can be proved similarly. (A slight technical hurdle arises from the fact that Helfgott’s thesis uses a different sign-convention for the Kasteleyn–Percus matrix, which results in different signs, and a different sum, for the inverse matrix; however, Helfgott’s methods are quite general, so there is no conceptual obstacle to applying them to Problem 12.)

I should mention that my original reason for examining the sum of the entries of the inverse Kasteleyn–Percus matrix was to see whether there might be formulas governing the individual entries themselves. Helfgott’s work provides such formulas.

Also, in this connection, Greg Kuperberg and Douglas Zare have some high-tech ruminations on the inverses of Kasteleyn–Percus matrices, and there is a chance that representation-theory methods will give a different way of proving the result.

Now we turn to a class of regions I call “pillows”. Here are a “0 mod 4” pillow of “order 5” and a “2 mod 4” pillow of “order 7”:

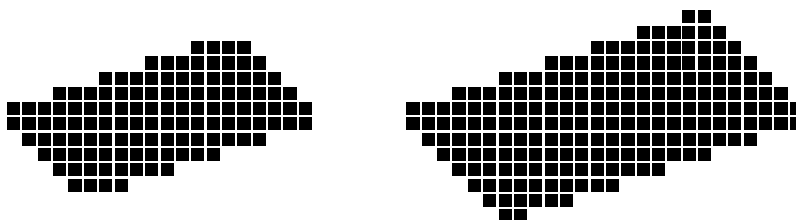

It turns out (empirically) that the number of tilings of the 0-mod-4 pillow of order n is a perfect square times the coefficient of x^n in the Taylor expansion of $(5 + 3x + x^2 - x^3)/(1 - 2x - 2x^2 - 2x^3 + x^4)$. This fact came to light in several steps. First it was noticed that the number of tilings has a comparatively small square-free part. Then it was noticed that in the derived sequence of square-free parts, many terms were roughly three times the preceding term. Then it was noticed that, by judiciously including some of the square factors, one could obtain a sequence in which each term was roughly three times the preceding

term. Finally it was noticed that this approximately geometric sequence satisfied a fourth-order linear recurrence relation.

Similarly, it appears that the number of tilings of the 2-mod-4 pillow of order n is a perfect square times the coefficient of x^n in the Taylor expansion of $(5 + 6x + 3x^2 - 2x^3)/(1 - 2x - 2x^2 - 2x^3 + x^4)$. (If you are wondering about “odd pillows”, I should mention that there is a nice formula for the number of tilings, but this is not an interesting result, because an odd pillow splits up into many small noncommunicating sub-regions such that a tiling of the whole region corresponds to a choice of tiling on each of the sub-regions.)

PROBLEM 13. Find a general formula for the number of domino tilings of even pillows.

Jockusch looked at the Aztec diamond of order n with a 2-by-2 hole in the center, for small values of n ; he came up with a conjecture for the number of domino tilings, subsequently proved by Gessel, Ionescu, and Propp [Gessel et al. ≥ 1999]. One way to generalize this is to make the hole larger, as was suggested by Douglas Zare and investigated by David Wilson. Here is an abridged and adapted version of the report David Wilson sent me on October 15, 1996:

Define the Aztec window with outer order y and inner order x to be the Aztec diamond of order y with an Aztec diamond of order x deleted from its center. For example, this is the Aztec window with orders 8 and 2:

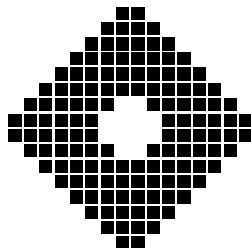

There are a number of interesting patterns that show up when we count tilings of Aztec windows. For one thing, if w is a fixed even number, and $y = x + w$, then for any w the number of tilings appears to be a polynomial in x . (When w is odd, and x is large enough, there are no tilings.) For $w = 6$, the polynomial is

$$8192x^8 + 98304x^7 + 573440x^6 + 2064384x^5 + 4988928x^4 \\ + 8257536x^3 + 9175040x^2 + 6291456x + 2097152.$$

This can be written as

$$2^{17} \left(\frac{1}{2} \left(x + \frac{3}{2} \right)^2 + \frac{7}{8} \right)^4$$

or as

$$2^{17} x^4 \circ \frac{1}{2}x + \frac{7}{8} \circ \left(x + \frac{3}{2} \right)^2,$$

where it is understood that these three polynomials get composed.

More generally, all the polynomials in x that arise in this fashion appear to “factor” in the sense of functional composition. Here are the factored forms of the polynomials for $n = 2, 4, 6, 8, 10$:

$$\begin{aligned}
 2^3x^4 &\circ 1 && \circ \left(x + \frac{1}{2}\right)^2 \\
 2^8x^2 &\circ x + 1 && \circ (x + 1)^2 \\
 2^{17}x^4 &\circ \frac{1}{2}x + \frac{7}{8} && \circ \left(x + \frac{3}{2}\right)^2 \\
 2^{28}x^2 &\circ \frac{1}{144}x^4 + \frac{7}{72}x^3 + \frac{41}{144}x^2 + \frac{11}{18}x + 1 && \circ (x + 2)^2 \\
 2^{43}x^4 &\circ \frac{1}{144}x^3 + \frac{61}{576}x^2 + \frac{451}{2304}x + \frac{967}{1024} && \circ \left(x + \frac{5}{2}\right)^2
 \end{aligned}$$

In general the rightmost polynomial is $(x + w/4)^2$, and the leftmost polynomial is either a perfect square, twice a fourth power, or half a fourth power, depending on $w \pmod 8$. A pattern for the middle polynomial however is elusive.

PROBLEM 14. Find a general formula for the number of domino tilings of Aztec windows.

PROGRESS. Constantin Chiscanu found a polynomial bound on the number of domino tilings of the Aztec window of inner order x and outer order $x + w$ [Chiscanu 1997]. Douglas Zare used the transfer-matrix method to show that the number of tilings is not just bounded by a polynomial, but given by a polynomial, for each fixed w [Zare 1997–98].

4. Miscellaneous

Now we come to some problems involving tiling that fit neither the domino-tiling nor the lozenge-tiling framework. Here the more general picture is that we have some periodic dissection of the plane by polygons, such that an even number of polygons meet at each vertex, allowing us to color the polygons alternately black or white. We then make a suitable choice of a finite region R composed of equal numbers of black and white polygons, and we look at the number of “diform” tilings of the region, where a *diform* is the union of two polygonal cells that share an edge. In the case of domino tilings, the underlying dissection of the infinite plane is the tiling by squares, 4 around each vertex; in the case of lozenge tilings, the underlying dissection of the infinite plane is the tiling by equilateral triangles, 6 around each vertex.

Other sorts of periodic dissections have already played a role in the theory of enumeration of matchings. For instance, there is a tiling of the plane by isosceles right triangles associated with a discrete reflection group in the plane; in this case, the right choice of R (see Figure 3) gives us a region that can be tiled in $5^{n^2/4}$ ways when n is even and in $5^{(n^2-1)/2}$ or $2 \cdot 5^{(n^2-1)/2}$ ways when n is odd [Yang 1991].

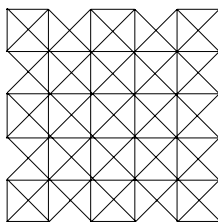

Figure 3. A fortress of order 5, with 2×5^6 diform tilings.

Similarly, in the tiling of the plane by triangles that comes from a 30 degree, 60 degree, 90 degree right triangle by repeatedly reflecting it in its edges, a certain region called the “Aztec dungeon” (see Figure 4) gives rise to a tiling problem in which powers of 13 occur (as was proved in not-yet-published work of Mihai Ciucu).

A key feature of these regions R is revealed by looking at the colors of those polygons in the dissection that share an edge with the border of R . One sees that the border splits up into four long stretches such that along each stretch, all the polygons that touch the border have the same color. It is not clear why regions with this sort of property should be the ones that give rise to the nicest enumerations, but this appears to happen in practice.

One interesting case arises from a rather symmetric dissection of the plane into equilateral triangles, squares, and regular hexagons, with 4 polygons meeting at each vertex and with no two squares sharing an edge. A typical diform tiling of this region (called a “dragon”) is shown in Figure 5. Empirically, one finds that the number of diform tilings is $2^{n(n+1)}$.

PROBLEM 15. Prove that the number of diform tilings of the dragon of order n is $2^{n(n+1)}$.

PROGRESS. Ben Wieland solved this problem (private communication).

Incidentally, the tiling shown in Figure 5 was generated using an algorithm that generates each of the possible diform tilings of the region with equal probability. It is no fluke that the tiling looks so orderly in the left and right corners of the region; this appears to be typical behavior in situations of this kind. This phenomenon has been analyzed rigorously for two tiling-models: lozenge tilings

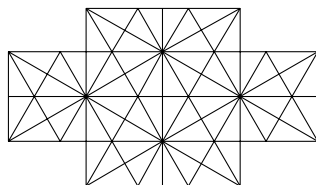

Figure 4. An Aztec dungeon of order 2, with 13^3 diform tilings.

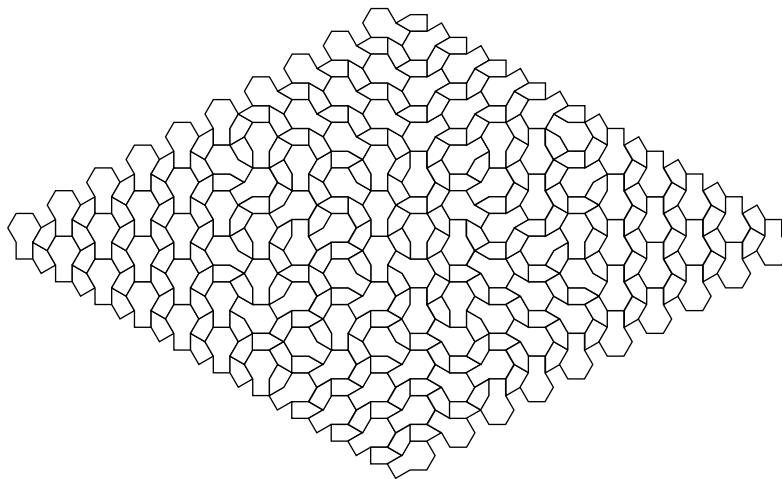

Figure 5. A dragon of order 10 (tiled).

of hexagons [Cohn et al. 1998b] and domino tilings of Aztec diamonds [Cohn et al. 1996].

One way to get a new dissection of the plane from an old one is to refine it. For instance, starting from the dissection of the plane into squares, one can draw in every k -th southwest-to-northeast diagonal. When k is 1, this is just a distortion of the dissection of the plane into equilateral triangles. When k is 2, this is a dissection that leads to finite regions for which the number of diform tilings is a known power of 2, thanks to a theorem of Chris Douglas [1996]. But what about $k = 3$ and higher?

For instance, we have the roughly hexagonal region shown in Figure 6; certain boundary vertices have been marked with a dot so as to bring out the large-scale 2, 3, 2, 2, 3, 2 hexagonal structure more clearly.

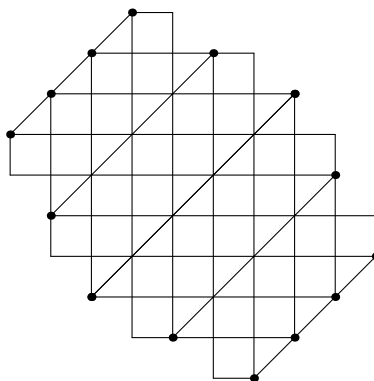

Figure 6. A region for Problem 16.

The cells of this region are triangles and squares. The region has $17920 = 2^9 \cdot 5 \cdot 7$ diform tilings.

PROBLEM 16. Find a formula for the number of diform tilings in the a, b, c quasi-hexagon in the dissection of the plane that arises from slicing the dissection into squares along every third upward-sloping diagonal.

One reason for my special interest in Problem 16 is that it seems to be a genuine hybrid of domino tilings of Aztec diamonds and lozenge tilings of hexagons.

PROGRESS. Ben Wieland solved this problem in the case $a = b = c$ (which, as it turns out, is also the solution to the case $a = b < c$ and the case $a = c < b$). In these cases the number of tilings is always a power of two. The general case does not yield round numbers, so there is no simple product formula.

The approach underlying Ben Wieland's solutions to the last two problems is a method of subgraph substitution that has already been of great use in enumeration of matchings of graphs. I will not go into great detail here on this method [Propp 1996; ≥ 1999], but here is an overview: One studies graphs with weights assigned to their edges, and one does weighted enumeration of matchings, where the weight of a matching is the product of the weights of the constituent edges. One then looks at local substitutions of subgraphs within a graph that preserve the sum of the weights of the matchings, or more generally, multiply the sum of the weights of the matchings by some predictable factor. Then the problem of weight-enumerating matchings of one graph reduces to the problem of weight-enumerating matchings of another graph. Iterating this procedure, one can often eventually reduce the graph to something easier to understand.

Problems 15 and 16 are just two instances of a broad class of problems arising from periodic graphs in the plane. A unified understanding of this class of problems has begun to emerge, by way of subgraph substitution. The most important open problem connected with this class of results is the following:

PROBLEM 17. Characterize those local substitutions that have a predictable effect on the weighted sum of matchings of a graph.

The most useful local substitution so far has been the one shown in Figure 7, where unmarked edges have weight 1 and where A, B, C, D are respectively obtained from a, b, c, d by dividing by $ad + bc$; if G and G' denote the graph before

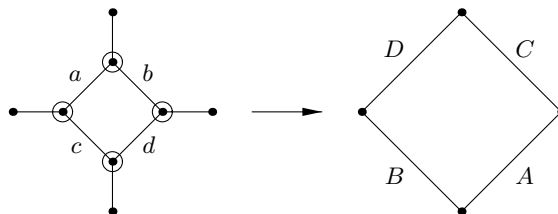

Figure 7. The “urban renewal” substitution.

and after the substitution, one can check that the sum of the weights of the matchings of G' equals the sum of the weights of the matchings of G divided by $ad+bc$.

It is required that the four innermost vertices have no neighbors other than the four vertices shown; this constraint is indicated by circling them. Noncircled vertices may have any number of neighbors.

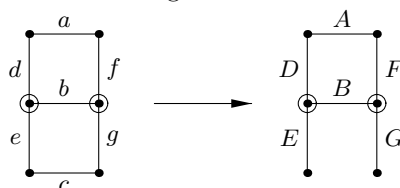

Figure 8. Rick Kenyon's substitution.

The substitution shown in Figure 8 (a straightforward generalization of a clever substitution due to Rick Kenyon) has also been of use. Here the new weights are not entirely determined by the old, but have a single degree of freedom; the relevant formulas can be written as

$$A = \frac{abc+ae g+cdf}{bc+eg}, \quad B = b, \quad D = \frac{dg}{bc+eg}E, \quad F = ef \frac{1}{E}, \quad G = (bc+eg) \frac{1}{E},$$

with E free. As before, the circled vertices must not have any neighbors other than the ones shown. In this case, the sum of the weights in the before-graph G is exactly equal to the sum of the weights in the after-graph G' ; there is no need for a correction factor like the $1/(ad+bc)$ that arises in urban renewal.

The extremely powerful “wye-delta” substitution of Colbourn, Provan, and Vertigan [Colbourn et al. 1995] should also be mentioned.

Up till now we have been dealing exclusively with bipartite planar graphs. We now turn to the less well-explored nonbipartite case.

For instance, one can look at the triangle graph of order n , shown in Figure 9 in the case $n = 4$. (Here n is the number of vertices in the longest row.)

Let $M(n)$ denote the number of matchings of the triangle graph of order n . When n is 1 or 2 mod 4, the graph has an odd number of vertices and $M(n)$ is 0; hence let us only consider the cases in which n is 0 or 3 mod 4. Here are the first few values of $M(n)$, expressed in factored form: $2, 2 \cdot 3, 2 \cdot 2 \cdot 3 \cdot 3 \cdot 61, 2 \cdot 2 \cdot 11 \cdot 29 \cdot 29, 2^3 \cdot 3^3 \cdot 5^2 \cdot 7^2 \cdot 19 \cdot 461, 2^3 \cdot 5^2 \cdot 37^2 \cdot 41 \cdot 139^2, 2^4 \cdot 73 \cdot 149 \cdot 757 \cdot 33721 \cdot 523657,$

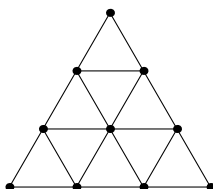

Figure 9. The triangle graph.

$2^4 \cdot 3^8 \cdot 17 \cdot 37^2 \cdot 703459^2, \dots$. It is interesting that $M(n)$ seems to be divisible by $2^{\lfloor (n+1)/4 \rfloor}$ but no higher power of 2; it is also interesting that when we divide by this power of 2, in the case where n is a multiple of 4, the quotient we get, in addition to being odd, is a perfect square times a small number (3, 11, 41, 17, \dots).

PROBLEM 18. How many matchings does the triangle graph of order n have?

PROGRESS. Horst Sachs [1997] has responded to this problem.

One can also look at graphs that are bipartite but not planar. A natural example is the n -cube (that is, the n -dimensional cube with 2^n vertices). It has been shown that the number of matchings of the n -cube goes like 1, 2, $9 = 3^2$, $272 = 16 \cdot 17$, $589185 = 3^2 \cdot 5 \cdot 13093, \dots$

PROBLEM 19. Find a formula for the number of matchings of the n -cube.

(This may be intractable; after all, the graph has exponentially many vertices.)

PROGRESS. László Lovász gave a simple proof of my (oral) conjecture that the number of matchings of the n -cube has the same parity as n itself. Consider the orbit of a particular matching of the n -cube under the group generated by the n standard reflections of the n -cube. If all the edges are parallel (which can happen in exactly n ways), the orbit has size 1; otherwise the size of the orbit is of the form 2^k (with $k \geq 1$)—an even number. The claim follows, and similar albeit more complex reasoning should allow one to compute the enumerating sequence modulo any power of 2. Meanwhile, L. H. Clark, J. C. George, and T. D. Porter have shown [Clark et al. 1997] that if one lets $f(n)$ denote the number of 1-factors in the n -cube, then

$$f(n)^{2^{1-n}} \sim n/e$$

as $n \rightarrow \infty$. It was subsequently pointed out by Bruce Sagan that the main result of Clark et al. [1997] is a special case of the theorem cited by Lovász and Plummer [1986, top of page 312].

Finally, we turn to a problem involving domino tilings of rectangles, submitted by Ira Gessel (what follows are his words):

We consider dimer coverings of an $m \times n$ rectangle, with m and n even. We assign a vertical domino from row i to row $i+1$ the weight $\sqrt{y_i}$ and a horizontal domino from column j to column $j+1$ the weight $\sqrt{x_j}$. For example, the covering

	$\sqrt{x_2}$		$\sqrt{x_5}$	$\sqrt{x_7}$		
$\sqrt{y_1}$		$\sqrt{y_1}$			$\sqrt{y_1}$	$\sqrt{y_1}$
	$\sqrt{x_2}$		$\sqrt{x_5}$	$\sqrt{x_7}$		

for $m = 2$ and $n = 10$ has weight $y_1^2 x_2 x_5 x_7$. (The weight will always be a product of integral powers of the x_i and y_j .)

Now I'll define what I call "dimer tableaux." Take an $m/2$ by $n/2$ rectangle and split it into two parts by a path from the lower left corner to the upper right corner. For example (with $m = 6$ and $n = 10$)

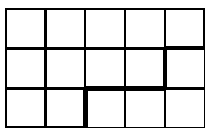

Then fill in the upper left part with entries from $1, 2, \dots, n-1$ so that for adjacent entries $\boxed{i} \boxed{j}$ we have $i < j-1$ and for adjacent entries $\boxed{i} \boxed{j}$ we have $i \leq j+1$, and fill in the lower-right partition with entries from $1, 2, \dots, m-1$ with the reverse inequalities ($\boxed{i} \boxed{j}$ implies $i \leq j+1$ and $\boxed{i} \boxed{j}$ implies $i < j-1$). We weight an i in the upper-left part by x_i and a j in the lower-right part by y_j .

THEOREM 1. *The sum of the weights of the $m \times n$ dimer coverings is equal to the sum of the weights of the $m/2 \times n/2$ dimer tableaux.*

My proof is not very enlightening; it essentially involves showing that both of these are counted by the same formula.

PROBLEM 20. Is there an "explanation" for this equality? In particular, is there a reasonable bijective proof? Notes:

- (1) The case $m = 2$ is easy: the 2×10 dimer covering above corresponds to the 1×5 dimer tableau

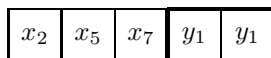

(there's only one possibility!).

- (2) If we set $x_i = y_i = 0$ when i is even (so that every two-by-two square of the dimer covering may be chosen independently), then the equality is equivalent to the identity

$$\prod_{i,j} (x_i + y_j) = \sum_{\lambda} s_{\lambda}(x) s_{\bar{\lambda}}(y);$$

compare [Macdonald 1995, p. 37]. This identity can be proved by a variant of Schensted's correspondence, so a bijective proof of the general equality would be essentially a generalization of Schensted. Several people have looked at the problem of a Schensted generalization corresponding to the case in which $y_i = 0$ when i is even.

- (3) The analogous results in which m or n is odd are included in the case in which m and n are both even. For example, if we take $m = 4$ and set $y_3 = 0$, then the fourth row of a dimer covering must consist of $n/2$ horizontal dominoes, which contribute $\sqrt{x_1 x_3 \cdots x_{n-1}}$ to the weight, so we are essentially looking at dimer coverings with three rows.

PROGRESS. A special case of the Robinson–Schensted algorithm given by Sundquist et al. [1997] can be used to get a bijection for a special case of the problem, in which one sets $y_i = 0$ for all i even, so that we are looking at dimer coverings (or domino tilings) in which every vertical domino goes from row $2i+1$ to row $2i+2$ for some i . These tilings are not very interesting because they break up into tilings of 2-by- n rectangles. But even so, the Robinson–Schensted bijection is nontrivial.

5. New Problems

Let $N(a, b)$ denote the number of matchings of the a -by- b rectangular grid. Kasteleyn showed that $N(a, b)$ is equal to the square root of the absolute value of

$$\prod_{j=1}^a \prod_{k=1}^b \left(2 \cos \frac{\pi j}{a+1} + 2i \cos \frac{\pi k}{b+1} \right).$$

Some number-theoretic properties of $N(a, b)$ follow from this representation (see, e.g., [Cohn 1999]) but lack a combinatorial explanation. The next two problems describe two such facts.

PROBLEM 21. Give a combinatorial proof of the fact that $N(a, b)$ divides $N(A, B)$ whenever $a+1$ divides $A+1$ and $b+1$ divides $B+1$.

PROGRESS. Bruce Sagan has given an answer in the “Fibonacci case” $a = 2$. A matching of a 2-by- $(kn-1)$ grid either splits up as a matching of a 2-by- $(n-1)$ grid on the left and a 2-by- $(kn-n)$ grid on the right or it splits up as a matching of a 2-by- $(n-2)$ grid on the left, a horizontal matching of a 2-by-2 grid in the middle, and a matching of a 2-by- $(kn-n-1)$ grid on the right. Hence

$$N(2, kn-1) = N(2, n-1)N(2, kn-n) + N(2, n-2)N(2, (k-1)n-1).$$

From this formula one can prove that $N(2, n-1)$ divides $N(2, kn-1)$ by induction on k . Volker Strehl has approached the problem in a different way; his ideas make it seem likely that a better combinatorial understanding of resultants, in combination with known interpretations of Chebyshev polynomials, would be helpful in approaching this problem.

PROBLEM 22. Give a combinatorial proof of the fact that $N(a, 2a)$ is always congruent to 1 mod 4.

(Pachter [1997] has demonstrated the sort of combinatorial methods one can use in such problems.)

Even without Kasteleyn’s formula, it is easy to show (e.g., via the transfer-matrix method) that for any fixed a , the sequence of numbers $N(a, b)$ (with b varying) satisfies a linear recurrence relation with constant coefficients. Indeed, consider all 2^a different ways of removing some subset of the a rightmost vertices

in the a -by- b grid; this gives us 2^a “mutilated” versions of the graph. We can set up recurrences that link matchings of mutilated graphs of width b with matchings of mutilated graphs of width b and $b - 1$, and standard algebraic methods allow us to turn this system of joint mutual recurrences of low degree into a single recurrence of high degree governing the particular sequence of interest, which enumerates matchings of unmutilated rectangles. The recurrence obtained in this way is not, however, best possible, as one can see even in the simple case $a = 2$.

PROBLEM 23 (STANLEY). Prove or disprove that the minimum degree of a linear recurrence governing the sequence $N(a, 1), N(a, 2), N(a, 3), \dots$ is $2^{\lfloor (a+1)/2 \rfloor}$.

PROGRESS. Observations made by Stanley [1985, p. 87] imply that the conjecture is true when $a + 1$ is an odd prime.

The idea of mutilating a graph by removing some vertices along its boundary leads us to the next problem. It has been observed for small values of n that if one removes equal numbers of black and white vertices from the boundary of a $2n$ -by- $2n$ square grid, the number of matchings of the mutilated graph is less than the number of matchings of the original graph. In fact, it appears to be true that one can delete *any* subset of the vertices of the square grid and obtain an induced graph with strictly fewer matchings than the original.

It is worth pointing out that not every graph shares this property with the square grid. For instance, if G is the Aztec diamond graph of order 5 and G' is the graph obtained from G by deleting the middle vertices along the northwest and northeast borders, then G has 32768 matchings while G' has 59493.

PROBLEM 24. Prove or disprove that every subgraph of the $2n$ -by- $2n$ grid graph has strictly fewer matchings.

Next we come to a variant on the Aztec dungeon region shown in Figure 4. Figure 10 shows an “hexagonal dungeon” with sides 2, 4, 4, 2, 4, 4. Matt Blum’s investigation of these shapes has led him to discover many patterns; the most striking of these patterns forms the basis of the next problem.

PROBLEM 25. Show that the hexagonal dungeon with sides $a, 2a, b, a, 2a, b$ has exactly

$$13^{2a^2} 14^{\lfloor a^2/2 \rfloor}$$

diform tilings, for all $b \geq 2a$.

Unmatchable bipartite graphs can sometimes give rise to interesting quasi-matching problems, either by way of KK^* (see Problem 6) or by systematic addition or deletion of vertices or edges. The former sort of problem simply asks for the determinant of KK^* (where we may assume that K has more columns than rows). When the underlying graph has equal numbers of black and white

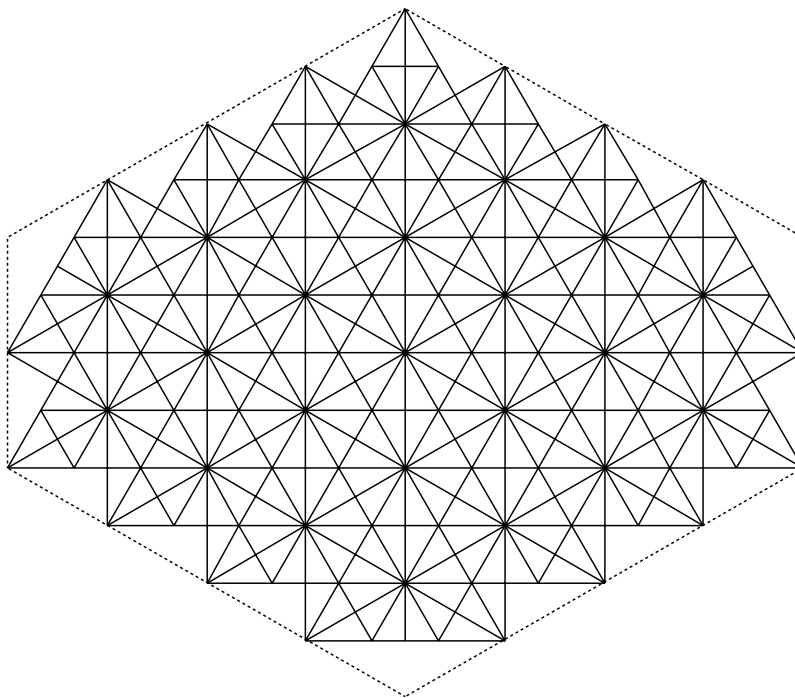

Figure 10. An hexagonal dungeon.

vertices, this is just the square of the number of matchings, but when K is a rectangular matrix, KK^* will in general have a nonzero determinant, even though the graph has no matchings.

PROBLEM 26. Calculate the determinant of KK^* where K is the Kasteleyn–Percus matrix of the a, b, c, d, e, f honeycomb graph.

(Note that in this case we can simply take K to be the bipartite adjacency matrix of the graph.)

Cases of special interest are $a, b+1, c, a+1, b, c+1$ and a, b, a, b, a, b hexagons. These two cases overlap in the one-parameter family of $a, a+1, a, a+1, a, a+1$ hexagons. For instance, in the case of the $3, 4, 3, 4, 3, 4$ hexagon, $\det(KK^*)$ is $2^8 \cdot 3^3 \cdot 7^6$.

PROBLEM 27. Calculate the determinant of KK^* where K is the Kasteleyn–Percus matrix of an m -by- n Aztec rectangle, or where K is the Kasteleyn–Percus matrix of the “fool’s diamond” of order n . (The fool’s diamond of order 3 is the following region:



Fool’s diamonds of higher orders are defined in a similar way.)

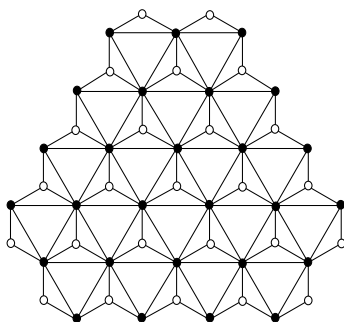

Figure 11. A hexagon with extra edges.

PROGRESS. In the case of Aztec rectangles, Matt Blum has found general formulas for $\det(KK^*)$ when m is 1, 2, or 3. For fool's diamonds, we get

$$\begin{aligned}
 &1 \\
 &2 \\
 &3 \cdot 5 \\
 &2^7 \cdot 3 \\
 &3^2 \cdot 5^3 \cdot 29 \\
 &2^9 \cdot 3 \cdot 5 \cdot 7 \cdot 13^2 \\
 &7^3 \cdot 13^4 \cdot 29^2 \\
 &2^{25} \cdot 3 \cdot 7^2 \cdot 17^3
 \end{aligned}$$

(One might also look at “fool’s rectangles”.)

Another thing one can do with an unmatchable graph is add extra edges. Even when this ruins the bipartiteness of the graph, there can still be interesting combinatorics. For instance, consider the 2, 4, 2, 4, 2, 4 hexagon-graph; it has an even number of vertices, but it has a surplus of black vertices over white vertices. We therefore introduce edges between every black vertex and the six nearest black vertices. (That is, in each hexagon of the honeycomb, we draw a triangle connecting the three black vertices, as in Figure 11.) Then the graph has $5187 = 3 \cdot 7 \cdot 13 \cdot 19$ matchings.

PROBLEM 28. Count the matchings of the a, b, c, d, e, f hexagon-graph in which extra edges have been drawn connecting vertices of the majority color.

What works for honeycomb graphs works (or seems to work) for square-grid graphs as well. If one adds edges joining each vertex of majority color to the four nearest like-colored vertices in the n by $n+2$ Aztec rectangle graph as in Figure 12, one gets a graph for which the number of matchings grows like $2^2 \cdot 3$, $2^3 \cdot 3 \cdot 7$, $2^7 \cdot 3 \cdot 11$, $2^{17} \cdot 5 \cdot 31$, etc. If one does the same for the holey $2n-1$ by $2n$ Aztec rectangle from which the central vertex has been removed, as in Figure 13, one gets the numbers $2^6 \cdot 7$, $2^9 \cdot 3^2 \cdot 13 \cdot 17$, $2^{23} \cdot 5^3 \cdot 31$, etc.

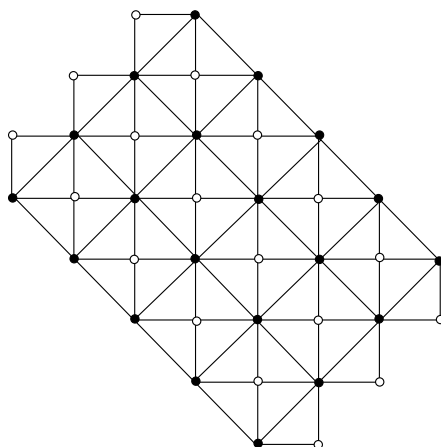

Figure 12. An Aztec rectangle with extra edges.

PROBLEM 29. Count the matchings of the a by b Aztec rectangle (with $a + b$ even) in which extra edges have been drawn connecting vertices of the majority color. Do the same for the $2n - 1$ by $2n$ holey Aztec rectangle.

Other examples of nonbipartite graphs for which the number of matchings has only small prime factors arise when one takes the quotient of a symmetrical bipartite graph modulo a symmetry-group at least one element of which interchanges the two colors; Kuperberg [1994] gives some examples of this. In general, there seem to be fewer product-formula enumerations of matchings for nonbipartite graphs than for bipartite graphs. Nevertheless, even in cases where no product formula has been found, there can be patterns in need of explanation.

Consider the one-parameter family of graphs illustrated in Figure 14 for the case $n = 7$ (based on the same nonbipartite infinite graph as Figures 12 and 13). Such a graph has an even number of vertices whenever n is congruent to 0 or 3

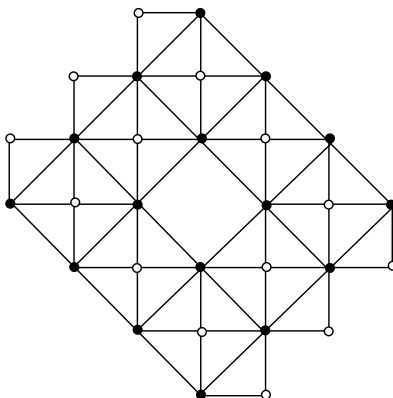

Figure 13. A holey Aztec rectangle with extra edges.

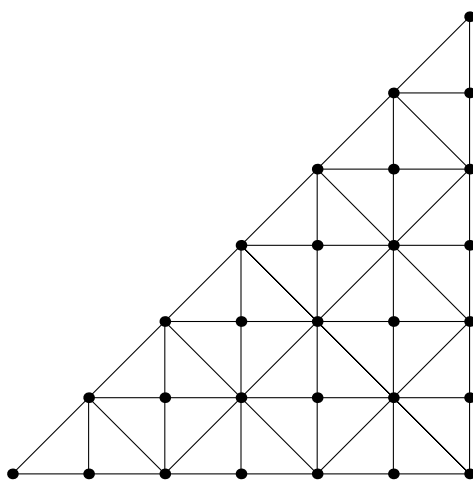

Figure 14. An isosceles right triangle graph with extra edges.

modulo 4. Here are the data for the first few cases, courtesy of Matt Blum:

n	number of matchings	factorization
3	3	3
4	6	$2 \cdot 3$
7	1065	$3 \cdot 5 \cdot 71$
8	6276	$2^2 \cdot 3 \cdot 523$
11	45949563	$3^2 \cdot 11 \cdot 464137$
12	807343128	$2^3 \cdot 3^2 \cdot 1109 \cdot 10111$
15	221797080594801	$3^2 \cdot 24644120066089$
16	11812299253803024	$2^4 \cdot 3 \cdot 246089567787563$
19	117066491250943949567763	$3 \cdot 89 \cdot 28289 \cdot 15499002371714201$
20	19100803250397148607852640	$2^5 \cdot 3^2 \cdot 5 \cdot 41 \cdot 367 \cdot 881534305952328473$

The following problem describes some of Blum’s conjectures:

PROBLEM 30. Show that for the isosceles right triangle graph with extra edges, the number of matchings is always a multiple of 3. Furthermore, show that the exact power of 2 dividing the number of matchings is $2^{n/4}$ when n is 0 modulo 4, and $2^0 (= 1)$ when n is 3 modulo 4.

This property of divisibility by 3 pops up in another problem of a similar flavor. Consider the graph shown in Figure 15, which is just like the one shown in Figure 9, except that half of the triangular cells have an extra vertex in them, connected to the three nearest vertices. (Note also the resemblance to Figure 11.)

PROBLEM 31. Show that for the equilateral triangle graph with extra vertices and edges, the number of matchings is always a multiple of 3.

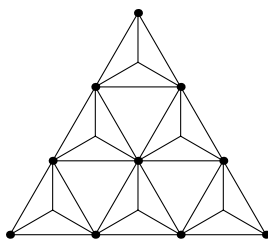

Figure 15. An equilateral triangle graph with extra vertices and edges.

(I refrain from making a conjecture about the exponent of 2, though the data contain patterns suggestive of a general rule.)

It may be too soon to try to assemble into one coherent picture all the diverse phenomena discussed in the preceding 31 problems. But I have noticed a gratuitous symmetry that governs many of the exact formulas, and I will close by pointing it out. Consider, for example, the MacMahon–Macdonald product

$$M_n = \prod_{i=0}^{n-1} \prod_{j=0}^{n-1} \prod_{k=0}^{n-1} \frac{i+j+k+2}{i+j+k+1}$$

that counts matchings of the n, n, n semiregular honeycomb graph. We find that the “second quotient” $M_{n-1}M_{n+1}/M_n^2$ is the rational function

$$\frac{27}{64} \frac{(3n-2)(3n-1)^2(3n+1)^2(3n+2)}{(2n-1)^3(2n+1)^3}$$

which is an even function of n .

The right hand side in Bo-Yin Yang’s theorem (giving the number of diabolo tilings of a fortress of order n) has a power of 5 whose exponent is $n^2/4$ when n is even and $(n^2-1)/4$ when n is odd; this too is an even function of n .

Domino tilings of Aztec diamonds are enumerated by the formula $2^{n(n+1)}$. Here the symmetry is a bit different: replacing n by $-1-n$ leaves the answer unaffected.

The right hand side of Mihai Ciucu’s theorem (giving the number of diform tilings of an Aztec dungeon of order n) has a power of 13 whose exponent is $(n+1)^2/3$ or $n(n+2)/3$ (according to whether or not n is 2 mod 3). so that the symmetry corresponds to replacing n by $-2-n$.

There are other instances of this kind that arise, in which some base is raised to the power of some quadratic function of n ; in each case, the quadratic function admits a symmetry that preserves the integrality of n (unlike, say, the quadratic function $n(3n+1)/2$, which as a function from integers to integers does not possess such a symmetry).

PROBLEM 32. For many of our formulas, the “algebraic” (right hand) side is invariant under substitutions that make the “combinatorial” (left hand) side meaningless, insofar as one cannot speak of graphs with negative numbers of

vertices or edges. Might this invariance nonetheless have some deeper significance?

Cohn [1999] has found another example of gratuitous symmetry related to tilings.

Acknowledgements

This research was conducted with the support of the National Science Foundation, the National Security Agency, and the M.I.T. Class of 1922 Career Development fund. I am deeply indebted to the past and present members of the Tilings Research Group for their many forms of assistance: Pramod Achar, Karen Acquista, Josie Ammer, Federico Ardila, Rob Blau, Matt Blum, Carl Bosley, Ruth Britto-Pacumio, Constantin Chiscanu, Henry Cohn, Chris Douglas, Edward Early, Nicholas Eriksson, David Farris, Lukasz Fidkowski, Marisa Gioioso, David Gupta, Harald Helfgott, Sharon Hollander, Dan Ionescu, Sameera Iyengar, Julia Khodor, Neelakantan Krishnaswami, Eric Kuo, Yvonne Lai, Ching Law, Andrew Menard, Alyce Moy, Anne-Marie Oreskovich, Ben Raphael, Vis Taraz, Jordan Weitz, Ben Wieland, Lauren Williams, David Wilson, Jessica Wong, Jason Woolever, and Laurence Yogman. I also acknowledge the helpful comments on this manuscript given by Henry Cohn and Richard Stanley, and the information provided by Jerry Dias, Michael Fisher and Horst Sachs concerning the connections between matching theory and the physical sciences.

References

Many of the papers in the bibliography are included as e-prints in the **xxx** mathematics archive; this is indicated by the inclusion of a **math.CO** identifier. Such e-prints can currently be accessed across the World Wide Web by appending the identifier to the URL <http://front.math.ucdavis.edu/> or <http://xxx.lanl.gov/abs/>.

- [Andrews 1976] G. E. Andrews, *The theory of partitions*, vol. 2, Encyclopedia of Mathematics and its Applications, Addison-Wesley, Reading, MA, 1976. Reprinted by Cambridge University Press, New York, 1998.
- [Baxter 1982] R. J. Baxter, *Exactly solved models in statistical mechanics*, Academic Press, London, 1982. Reprinted 1989.
- [Carlitz and Stanley 1975] L. Carlitz and R. P. Stanley, “Branchings and partitions”, *Proc. Amer. Math. Soc.* **53**:1 (1975), 246–249.
- [Chiscanu 1997] C. Chiscanu, “Comments on Propp’s problem 14”, 1997. Available at <http://math.wisc.edu/~propp/chiscanu.ps.gz>.
- [Ciucu 1997] M. Ciucu, “Enumeration of perfect matchings in graphs with reflective symmetry”, *J. Combin. Theory Ser. A* **77**:1 (1997), 67–97.
- [Ciucu 1998] M. Ciucu, “Enumeration of lozenge tilings of punctured hexagons”, *J. Combin. Theory Ser. A* **83**:2 (1998), 268–272.

- [Ciucu and Krattenthaler 1999] M. Ciucu and C. Krattenthaler, “The number of centered lozenge tilings of a symmetric hexagon”, *J. Combin. Theory Ser. A* **86** (1999), 103–126.
- [Clark et al. 1997] L. H. Clark, J. C. George, and T. D. Porter, “On the number of 1-factors in the n -cube”, *Congr. Numer.* **127** (1997), 67–69.
- [Cohn 1999] H. Cohn, “2-adic behavior of numbers of domino tilings”, *Electron. J. Combin.* **6** (1999), R14.
- [Cohn et al. 1996] H. Cohn, N. Elkies, and J. Propp, “Local statistics for random domino tilings of the Aztec diamond”, *Duke Math. J.* **85**:1 (1996), 117–166.
- [Cohn et al. 1998a] H. Cohn, R. Kenyon, and J. Propp, “A variational principle for domino tilings”, 1998. See <http://www.math.wisc.edu/~propp/variational.ps>. Submitted to *J. Amer. Math. Soc.*
- [Cohn et al. 1998b] H. Cohn, M. Larsen, and J. Propp, “The shape of a typical boxed plane partition”, *New York J. Math.* **4** (1998), 137–165.
- [Colbourn et al. 1995] C. J. Colbourn, J. S. Provan, and D. Vertigan, “A new approach to solving three combinatorial enumeration problems on planar graphs”, *Discrete Appl. Math.* **60** (1995), 119–129.
- [Cyvin and Gutman 1988] S. J. Cyvin and I. Gutman, *Kekulé structures in benzenoid hydrocarbons*, Lecture Notes in Chemistry **46**, Springer, Berlin, 1988.
- [David and Tomei 1989] G. David and C. Tomei, “The problem of the calissons”, *Amer. Math. Monthly* **96** (1989), 429–431.
- [Douglas 1996] C. Douglas, “An illustrative study of the enumeration of tilings: conjecture discovery and proof techniques”, 1996. Available at <http://www.math.wisc.edu/~propp/Enumeration.ps>.
- [Eisenkölbl 1997] T. Eisenkölbl, “Rhombus tilings of a hexagon with three fixed border tiles”, 1997. Available at math.CO/9712261. To appear in *J. Combin. Theory Ser. A*.
- [Eisenkölbl 1998] T. Eisenkölbl, “Rhombus tilings of a hexagon with two triangles missing on the symmetry axis”, 1998. Available at math.CO/9810019. To appear in *J. Combin. Theory Ser. A*.
- [Elkies et al. 1992] N. Elkies, G. Kuperberg, M. Larsen, and J. Propp, “Alternating sign matrices and domino tilings”, *J. Algebraic Combin.* **1** (1992), 111–132 and 219–234.
- [Fowler and Rushbrooke 1937] R. H. Fowler and G. S. Rushbrooke, “An attempt to expand the statistical theory of perfect solutions”, *Trans. Faraday Soc.* **33** (1937), 1272–1294.
- [Fulmek and Krattenthaler 1998a] M. Fulmek and C. Krattenthaler, “The number of rhombus tilings of a symmetric hexagon which contain a fixed rhombus on the symmetry axis, I”, *Ann. Combin.* **2** (1998), 19–40. Available at <http://radon.mat.univie.ac.at/People/kratt/artikel/fixrhom2.html> or math.CO/9712244.
- [Fulmek and Krattenthaler 1998b] M. Fulmek and C. Krattenthaler, “The number of rhombus tilings of a symmetric hexagon which contain a fixed rhombus on the symmetry axis, II”, 1998. Available at <http://radon.mat.univie.ac.at/People/kratt/artikel/fixrhom3.html>.

- [Gessel and Viennot 1985] I. Gessel and G. Viennot, “Binomial determinants, paths, and hook length formulae”, *Adv. Math.* **58** (1985), 300–321.
- [Gessel et al. \geq 1999] I. Gessel, A. Ionescu, and J. Propp, In preparation.
- [Gordon and Davison 1952] M. Gordon and W. H. T. Davison, “Theory of resonance topology of fully aromatic hydrocarbons, I”, *J. of Chem. Phys.* **20** (1952), 428–435.
- [Grensing et al. 1980] D. Grensing, I. Carlsen, and H.-C. Zapp, “Some exact results for the dimer problem on plane lattices with non-standard boundaries”, *Phil. Mag. A* **41** (1980), 777–781.
- [Helfgott 1998] H. Helfgott, *Edge effects on local statistics in lattice dimers: a study of the Aztec diamond finite case*, Bachelor’s thesis, Brandeis University, 1998. Available at <http://www.math.wisc.edu/~propp/helfgott.ps>.
- [Helfgott and Gessel 1999] H. Helfgott and I. Gessel, “Tilings of diamonds and hexagons with defects”, *Electron. J. Combin.* **6** (1999), R16.
- [Jockusch 1994] W. Jockusch, “Perfect matchings and perfect squares”, *J. Combin. Theory Ser. A* **67** (1994), 100–115.
- [John and Sachs 1985] P. John and H. Sachs, “Wegesysteme und Linearfaktoren in hexagonalen und quadratischen Systemen”, pp. 85–101 in *Graphen in Forschung und Unterricht*, Barbara Franzbecker Verlag, Bad Salzdetfurth, 1985.
- [Kasteleyn 1961] P. W. Kasteleyn, “The statistics of dimers on a lattice I: The number of dimer arrangements on a quadratic lattice”, *Physica* **27** (1961), 1209–1225.
- [Kasteleyn 1967] P. W. Kasteleyn, “Graph theory and crystal physics”, in *Graph theory and theoretical physics*, edited by F. Harary, Academic Press, 1967.
- [Kenyon 1997] R. Kenyon, “Local statistics of lattice dimers”, *Ann. Inst. H. Poincaré Probab. Statist.* **33** (1997), 591–618.
- [Krattenthaler 1997] C. Krattenthaler, “Schur function identities and the number of perfect matchings of holey Aztec rectangles”, 1997. Available at <http://radon.mat.univie.ac.at/People/kratt/artikel/holeyazt.html> or math.CO/9712204.
- [Kuperberg 1994] G. Kuperberg, “Symmetries of plane partitions and the permanent-determinant method”, *J. Combin. Theory Ser. A* **68:1** (1994), 115–151.
- [Kuperberg 1998] G. Kuperberg, “An exploration of the permanent-determinant method”, *Electron. J. Combin.* **5** (1998), R46.
- [Lieb 1967] E. H. Lieb, “Residual entropy of square ice”, *Phys. Rev.* **162** (1967), 162–172.
- [Lovász and Plummer 1986] L. Lovász and M. D. Plummer, *Matching theory*, Elsevier, Amsterdam and New York, 1986.
- [Macdonald 1995] I. G. Macdonald, *Symmetric functions and Hall polynomials*, 2nd ed., Oxford Univ. Press, 1995.
- [MacMahon 1915–16] P. A. MacMahon, *Combinatory analysis* (2 v.), Cambridge University Press, 1915–16. Reprinted by Chelsea, New York, 1960.
- [Mills et al. 1983] W. H. Mills, D. P. Robbins, and H. Rumsey Jr., “Alternating sign matrices and descending plane partitions”, *J. Combin. Theory Ser. A* **34** (1983), 340–359.

- [Okada and Krattenthaler 1998] S. Okada and C. Krattenthaler, “The number of rhombus tilings of a ‘punctured’ hexagon and the minor summation formula”, *Adv. in Appl. Math.* **21** (1998), 381–404.
- [Onsager 1944] L. Onsager, “Crystal statistics, I: a two-dimensional model with an order-disorder transition”, *Phys. Rev.* **65** (1944), 117–149.
- [Pachter 1997] L. Pachter, “Combinatorial approaches and conjectures for 2-divisibility problems concerning domino tilings of polyominoes”, *Electron. J. Combin.* **4** (1997), R29.
- [Pachter and Kim 1998] L. Pachter and P. Kim, “Forcing matchings on square grids”, *Discrete Math.* **190**:1-3 (1998), 287–294.
- [Percus 1969] J. Percus, “One more technique for the dimer problem”, *J. Math. Phys.* **10** (1969), 1881–1888.
- [Propp 1996] J. Propp, “Counting constrained domino tilings of Aztec diamonds”, 1996. Available at <http://math.wisc.edu/~propp/fpsac96.ps.gz>.
- [Propp \geq 1999] J. Propp, “Memo on urban renewal”. See <http://math.wisc.edu/~propp/renewal.ps.gz>.
- [Sachs 1990] H. Sachs, “Counting perfect matchings in lattice graphs”, pp. 577–584 in *Topics in combinatorics and graph theory*, edited by R. Bodendiek and R. Henn, Physica-Verlag, Heidelberg, 1990.
- [Sachs 1997] H. Sachs, “A contribution to problem 18”, 1997. Available at <http://math.wisc.edu/~propp/kekule>.
- [Saldanha 1997] N. Saldanha, “Generalized Kasteleyn matrices and their singular values”, 1997. Available at <http://www.upa.ens-lyon.fr/~nsaldanh/kk.ps.gz> or <http://www.impa.br/~nicolau/kk.ps.gz>.
- [Stanley 1971] R. Stanley, “Theory and application of plane partitions”, *Stud. Appl. Math.* **50** (1971), 167–188 and 259–279.
- [Stanley 1985] R. Stanley, “On dimer coverings of rectangles of fixed width”, *Discrete Appl. Math.* **12** (1985), 81–87.
- [Stanley 1986a] R. Stanley, “A baker’s dozen of conjectures concerning plane partitions”, pp. 285–293 in *Combinatoire énumérative*, edited by G. Labelle and P. Leroux, Lecture Notes in Math. **1234**, Springer, Berlin, 1986.
- [Stanley 1986b] R. Stanley, “Symmetries of plane partitions”, *J. Combin. Theory Ser. A* **43** (1986), 103–113.
- [Sundquist et al. 1997] T. S. Sundquist, D. G. Wagner, and J. West, “A Robinson-Schensted algorithm for a class of partial orders”, *J. Combin. Theory Ser. A* **79** (1997), 36–52.
- [Temperley and Fisher 1961] H. N. V. Temperley and M. E. Fisher, “Dimer problem in statistical mechanics — an exact result”, *Phil. Mag.* **6** (1961), 1061–1063.
- [Turnbull 1960] H. W. Turnbull, *Theory of determinants, matrices, and invariants*, Dover, New York, 1960.
- [Valiant 1979] L. Valiant, “The complexity of computing the permanent”, *Theoret. Comput. Sci.* **8** (1979), 189–201.

[Yang 1991] B.-Y. Yang, *Two enumeration problems about the Aztec diamonds*, Ph.D. thesis, Mass. Inst. Tech., 1991.

[Zare 1997–98] D. Zare, email from May 20, 1997 and March 2, 1998. Available at <http://math.wisc.edu/~propp/zare>.

JAMES PROPP
DEPARTMENT OF MATHEMATICS
UNIVERSITY OF WISCONSIN
MADISON, WI 53706
UNITED STATES
propp@math.wisc.edu