

# Diode Limiting and Clamping Circuits

## OBJECTIVES

After performing this experiment, you will be able to:

1. Explain the difference between clipping and clamping circuits.
2. Calculate and measure the voltage limits of both biased and unbiased clipping circuits.
3. Predict and measure the effect of a dc bias voltage on a clamping circuit.

## MATERIALS NEEDED

Resistors:

Two 10 k $\Omega$ , one 47 k $\Omega$

Two signal diodes (1N914 or equivalent)

One 47  $\mu$ F capacitor

For Further Investigation:

One 10 k $\Omega$  potentiometer

One 1.0 k $\Omega$  resistor

## SUMMARY OF THEORY

In addition to the use of diodes as rectifiers, there are a number of other interesting applications. For example, diodes are frequently used in applications such as waveshaping, mixers, detectors, protection circuits, and switching circuits. In this experiment, you will investigate two widely used applications of diode circuits: diode *limiter* circuits (also called *clippers*) and diode *clamping* circuits. Diode clipping circuits are used to prevent a waveform from exceeding some particular limit, either negative or positive. For example, assume it is desired to remove the portion of a sine wave that exceeds +5.0 V. The bias voltage,  $V_B$ , is set to a voltage 0.7 V less than the desired clipping level. The circuit in Figure 33-1 will limit the waveform because the diode will be forward-biased whenever the signal exceeds +5.0 V. This places  $V_B$  in parallel with  $R_L$  and prevents the input voltage from going above +5.0 V. When the signal is less than +5.0 V, the diode is reverse-biased and appears to be an open circuit. If, instead, it was desired to clip the waveform below some specified level, the diode can be reversed and  $V_B$  is set to 0.7 V greater than the desired clipping level.

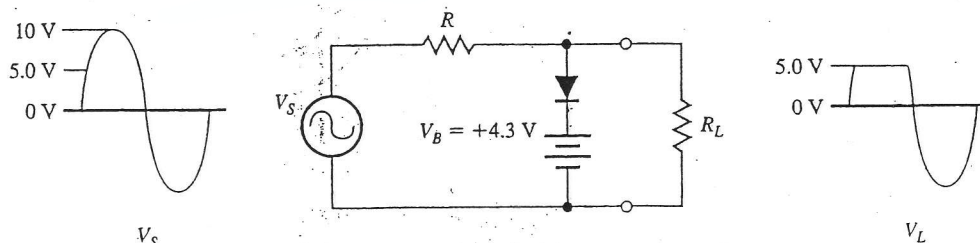

Figure 33-1

Diode clamping circuits are used to shift the dc level of a waveform. When a signal is passed through a capacitor, the dc component is blocked. A clamping circuit can restore the dc level. For this reason these circuits are sometimes called *dc restorers*. Diode clamping action is illustrated in Figure 33-2 for both positive and negative clamping circuits. The diode causes the series capacitor to have a low-resistance charging path and a high resistance discharge path through  $R_L$ . As long as the  $RC$  time constant is long compared to the period of the waveform, the capacitor will be charged to the peak value of the input waveform. This action requires several cycles of the input signal to charge the capacitor. The output load resistor sees the sum of the dc level on the capacitor and the input voltage.

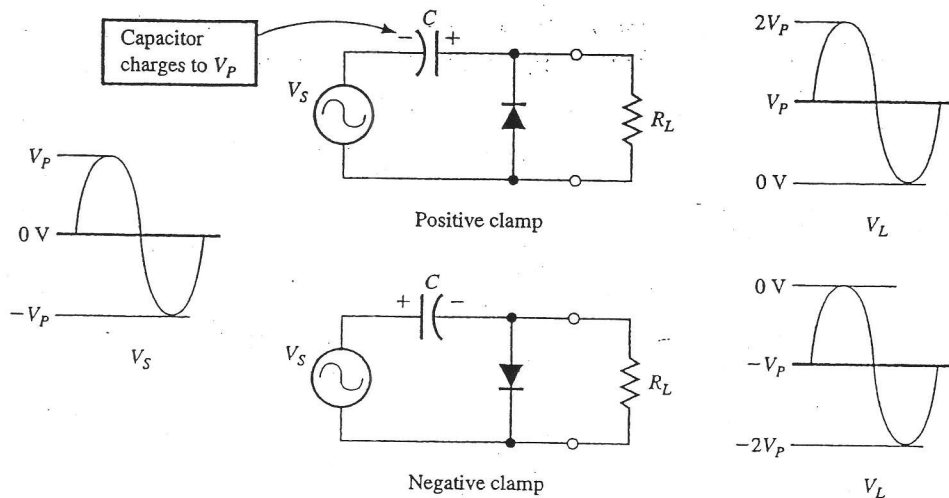

Figure 33-2

### PROCEDURE

1. Connect the circuit shown in Figure 33-3. Connect the signal generator to the circuit and set it for a  $6.0\text{ V}_{pp}$  sine wave at a frequency of  $1.0\text{ kHz}$  with no dc offset. Observe the input and output waveforms on the oscilloscope by connecting it as shown. Notice that  $R_2$  and  $R_L$  form a voltage divider, causing the load voltage to be less than the source voltage.  $R_1$  will provide a dc return path in case the signal generator is capacitively coupled.

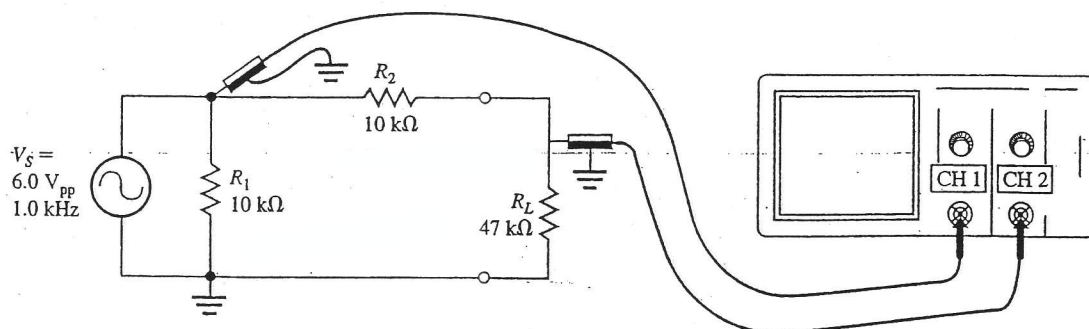

Figure 33-3

2. Now add the diode to the circuit as shown in Figure 33-4. Look carefully at the output waveform. Note the zero volt level.  
 measure the waveform across  $R_2$ . Sketch the observed waveforms on Plot 33-1.

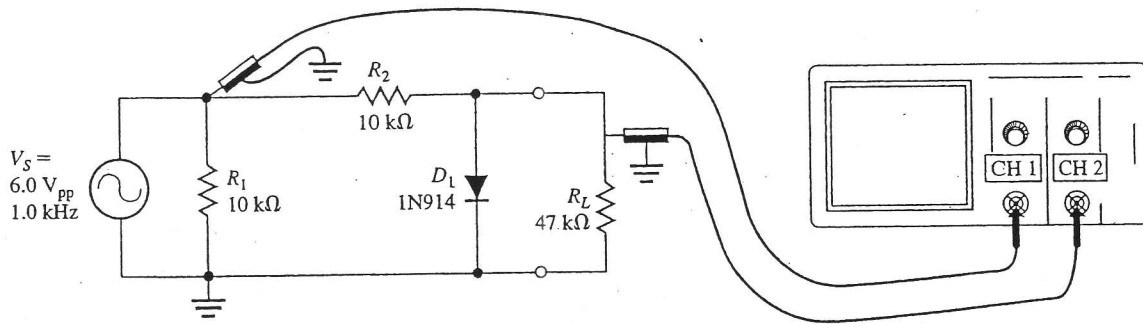
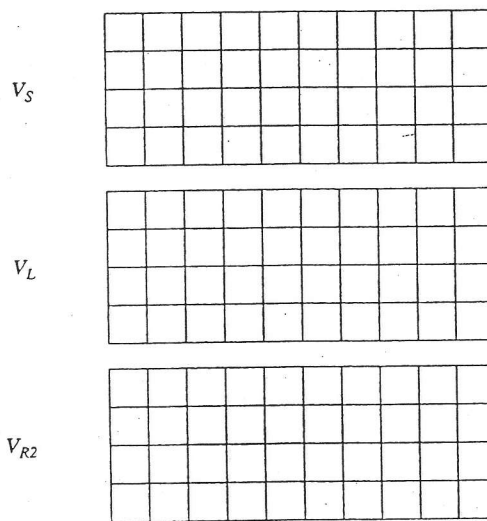

Figure 33-4



Plot 33-1

- Remove the cathode of the diode from ground and connect it to the power supply as shown in Figure 33-5. Vary the voltage from the supply and describe the results.

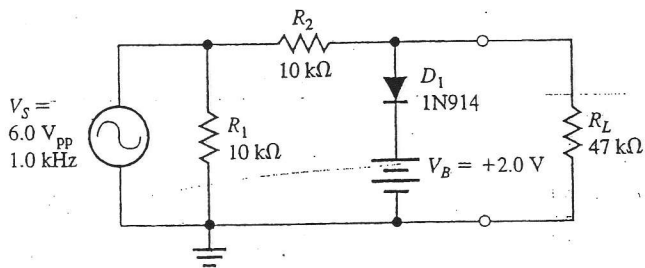

Figure 33-5

4. Reverse the diode in the circuit of Figure 33-5. Vary the dc voltage and describe the results.

5. Replace the positive power supply with a negative supply. Again, vary the dc voltage and describe the results.

7. Connect the clamp circuit shown in Figure 33-6. Couple the oscilloscope with dc coupling and observe the output voltage. Vary the input voltage and observe the result.  
Observations:

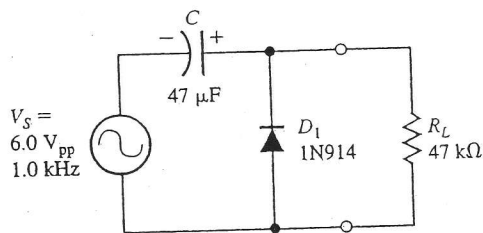

Figure 33-6

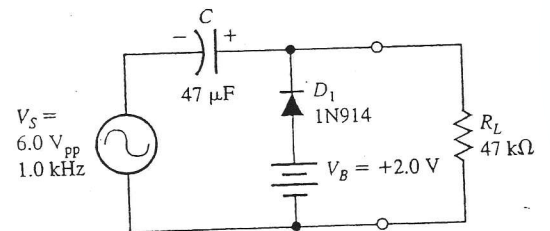
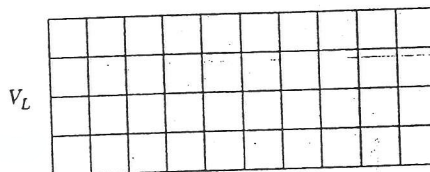

Figure 33-7

8. Add a dc voltage to the diode by connecting the power supply as shown in Figure 33-7. Sketch the output waveform on Plot 33-2 below. Show the dc level on your sketch.



Plot 33-2

9. Find out what happens if the positive dc voltage is replaced with a negative dc source.  
Observations:

## CONCLUSION

### EVALUATION AND REVIEW QUESTIONS

1. (a) In step 2, you observed the voltage waveform across the series resistor,  $R_2$ . The waveform observed across  $R_2$  could have been predicted by applying Kirchhoff's voltage law to  $V_S$  and  $V_L$ . Explain.  
  
(b) The size of  $R_2$  affects the output waveform on the load. Predict the effect of changing  $R_2$  to 1.0 k $\Omega$ .
2. For the circuit of Figure 33-6, describe what would happen to the output voltage if the capacitor were shorted.
3. For the circuit of Figure 33-7, what change would you expect in the output if the diode were reversed?
4. Explain the difference between a limiting and a clamping circuit.

5. Predict the maximum and minimum output voltage for the clipping circuit shown in Figure 33-8:

$V_{\min} =$  \_\_\_\_\_

$V_{\max} =$  \_\_\_\_\_

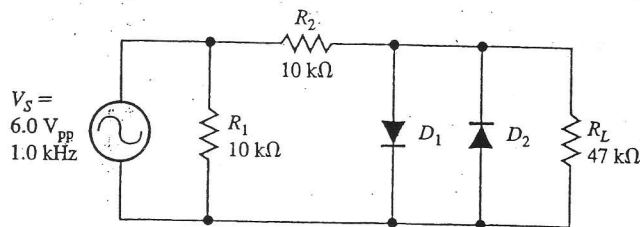

Figure 33-8

**FOR FURTHER INVESTIGATION**

A variable clipping level is possible from a fixed power supply by setting the reference voltage with a voltage divider as shown in Figure 33-9. Connect the circuit and determine the maximum and minimum clipping levels by measuring the output voltage as the potentiometer is varied.

Minimum clipping level = \_\_\_\_\_

Maximum clipping level = \_\_\_\_\_

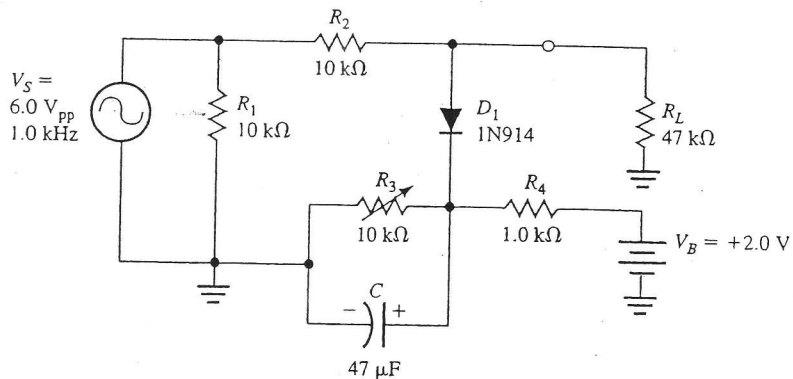

Figure 33-9